

Bianchi Venidng Group - Repuesto  
Catálogo relacionado con :

-  **Maquinas de Cafe**
-  **BVM 972 - Free Standing**
-  **BV972ES08GG - BVM972 E5S DC DM PD**

TIENDA VENDING

## Resumen

|  |           |
|--|-----------|
| <b>Maquinas de Cafe   BVM 972 - Free Standing   BV972ES08GG - BVM972 E5S DC DM PD</b>                                  | <b>1</b>  |
| <b>Maquinas de Cafe   BVM 972 - Free Standing   BV972ES08GG - BVM972 E5S DC DM PD   PORTA</b>                          | <b>2</b>  |
| INTERNO PORTA (646)  | 3         |
| FRONTE PORTA (829)   | 5         |
| KIT ASTA SERRATURA RINFORZATA (910)  | 7         |
| <b>Maquinas de Cafe   BVM 972 - Free Standing   BV972ES08GG - BVM972 E5S DC DM PD   CASSONE</b>                        | <b>9</b>  |
| CASSONE (819)  | 10        |
| <b>Maquinas de Cafe   BVM 972 - Free Standing   BV972ES08GG - BVM972 E5S DC DM PD   EROGAZIONE &amp; DISTRIBUZIONE</b> | <b>12</b> |
| C/O COLONNA E SGANCIATORE BICCHIERI (627)  | 13        |
| ASSIEME SUPPORTO UGELLI ZUCCHERO (827)   | 15        |
| DISTRIBUTORE PALETTE (918)   | 17        |
| <b>Maquinas de Cafe   BVM 972 - Free Standing   BV972ES08GG - BVM972 E5S DC DM PD   C/O ESPRESSO</b>                   | <b>19</b> |
| CALDERA(8)   | 20        |
| GRUPO CAFE' PLASTICO(1)  | 22        |
| MOTORIDUTTORE GRUPPO CAFFE' (483)  | 24        |
| ASS. DOSATORE CAFFE' (539)   | 26        |
| ASSIEME PISTONE (822)  | 28        |
| TRAMOGGIA CAFFE' DX-SX (818)   | 30        |
| C/O MACINA-DOSATORE (817)  | 32        |
| <b>Maquinas de Cafe   BVM 972 - Free Standing   BV972ES08GG - BVM972 E5S DC DM PD   C/O ESPRESSO - SOLUBILI</b>        | <b>34</b> |
| C/O SUPP. MACINADOSATORE-MOTORIDUTTORI SCATOLE DOSATRICI ( 815)  | 35        |
| C/O CASSETTO BVM 972 DC (821)  | 37        |
| <b>Maquinas de Cafe   BVM 972 - Free Standing   BV972ES08GG - BVM972 E5S DC DM PD   C/O SOLUBILI</b>                   | <b>39</b> |
| SCATOLE DOSATRICI POLVERI (654)  | 40        |
| C/O CALDAIA SOLUBILI 5 ELETTRIC. (820)   | 42        |
| C/O SCATOLA ORZO/CAFFE BV972 (826)   | 44        |
| PARTI DI COMPLETAMENTO (824)   | 46        |
| <b>Maquinas de Cafe   BVM 972 - Free Standing   BV972ES08GG - BVM972 E5S DC DM PD   PARTI ELETTRICHE</b>               | <b>48</b> |
| ASSIEME SCATOLA ELETTRICA (652)  | 49        |
| SCHEDA ELETTRONICA - MASTER (800)  | 51        |
| NEON E PARTI ELETTRICHE (828)  | 53        |
| <b>Maquinas de Cafe   BVM 972 - Free Standing   BV972ES08GG - BVM972 E5S DC DM PD   COMPONENTI IDRAULICI</b>           | <b>55</b> |
| ELETTRIVALVOLA E VASCETTA INGRESSO ACQUA (831)   | 56        |
| <b>Otras tablas</b>  | <b>58</b> |
| COMPONENTI SUPPORTO UGELLI (603)   | 59        |
| COMPONENTI SGANCIA BICCHIERI (628)   | 61        |
| SERRATURA (631)  | 63        |
| VANO EROGAZIONE (633)  | 65        |
| INTRODUZIONE MONETA (647)  | 67        |
| PULSANTIERA - VISUALIZZATORE (825)   | 69        |
| MOLINO (816)   | 71        |
| COMPONENTI PER MISCELATORI (823)   | 73        |

POMPA ACQUA - RILEVATORE DI FLUSSO (830)

COMPONENTI ELETTROVALVOLA SOLUBILI (832)

COMPONENTI SCATOLA ORZO/CAFFE (908)

75

77

79

**TIENDA VENDING**

Tablas del grupo :

- 🔗 Maquinas de Cafe
  - 📁 BVM 972 - Free Standing
    - 📁 BV972ES08GG - BVM972 E5S DC DM PD
      - 📁 PORTA



Tabla: INTERNO PORTA (646)

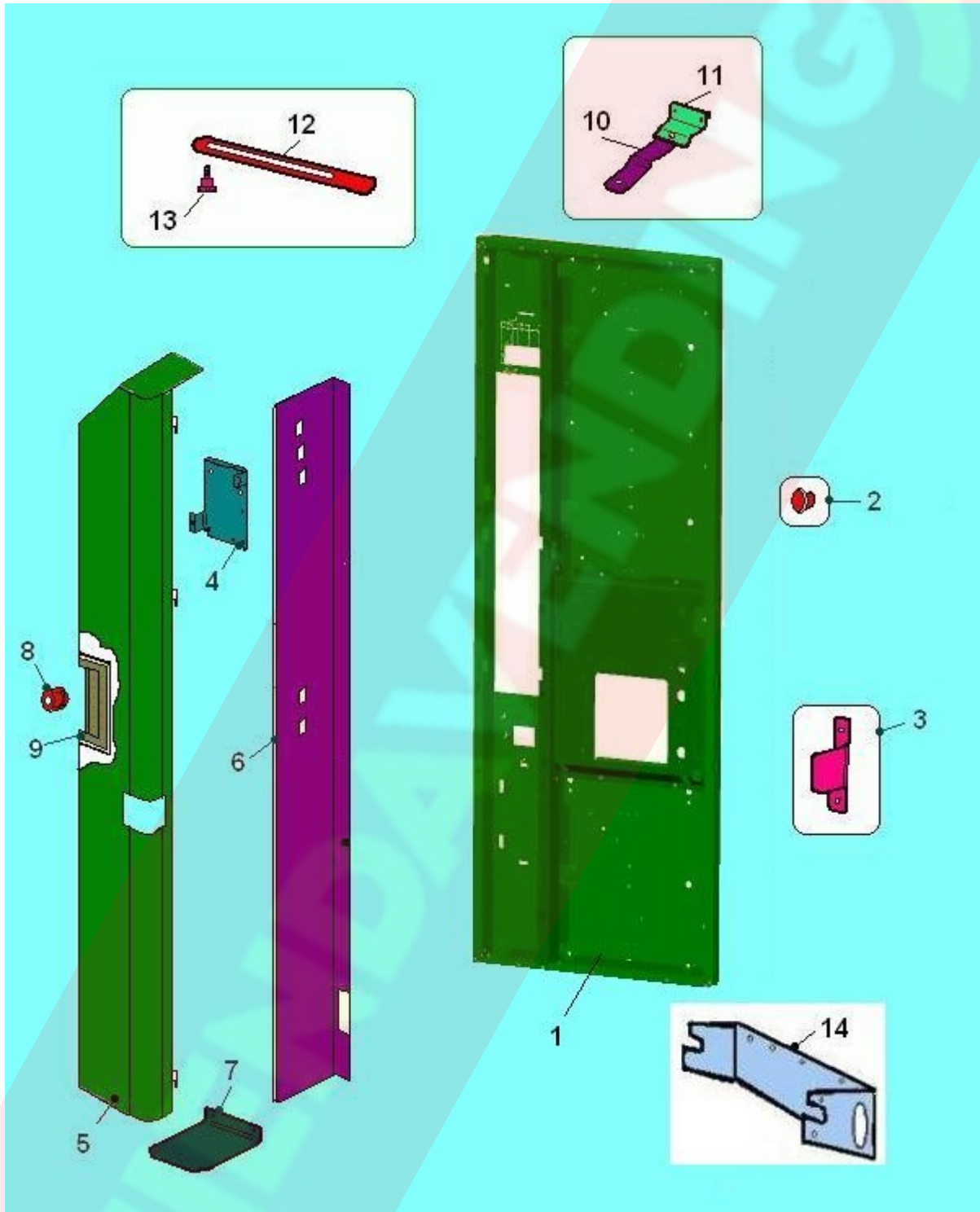

## INTERNO PORTA (646) - Detalle de los artículos

| POSICIÓN | CODIGO DE REPUESTO | Accesorios | DESCRIPCIÓN                    | Para cada artículo principal<br>multiplique q.ty cerca |
|----------|--------------------|------------|--------------------------------|--|
| 1        | 01831812-03        |            | ASS.TELAIO PORTA BV971 IVS     |  |
| 2        | 00104883           |            | paragolpes                     |  |
| 3        | 01827311-01        |            | PIASTRINA INTERRUETTORE BV971  |  |
| 4        | 01839622           |            | ASS.SUPPORTO CPU STANDARD      |  |
| 5        | 01826311-01        |            | COPERT.SIST.PAGAMENT.BV971 IVS |  |
| 6        | 01826511-02        |            | SPALLA PROTEZ. SIST. PAGAMENTO |  |
| 7        | 01826411-01        |            | FONDO PROTEZ. SIST.PAGAMENTO   |  |
| 8        | 20022316           |            | MAGNETE TONDO XPORT.VANO BICC. |  |
| 9        | 05238516           |            | MANIGL.PLS SOUTHCO BV971 IVS   |  |
| 10       | 01812611-01        |            | FERMO COLONNA BICCHIERI BVM95  |  |
| 11       | 01826911-01        |            | SQUADRET.FERMO ROTAZ.TAMP      |  |
| 12       | 01827911-01        |            | ASTA FERMO PORTA BV971 IVS     |  |
| 13       | 19055511           |            | tornillo x soporte cerradu     |  |
| 14       | 01452011-01        |            | SUPP.VASCH.VANO EROG. ORION    |  |

Tabla: FRONTE PORTA (829)

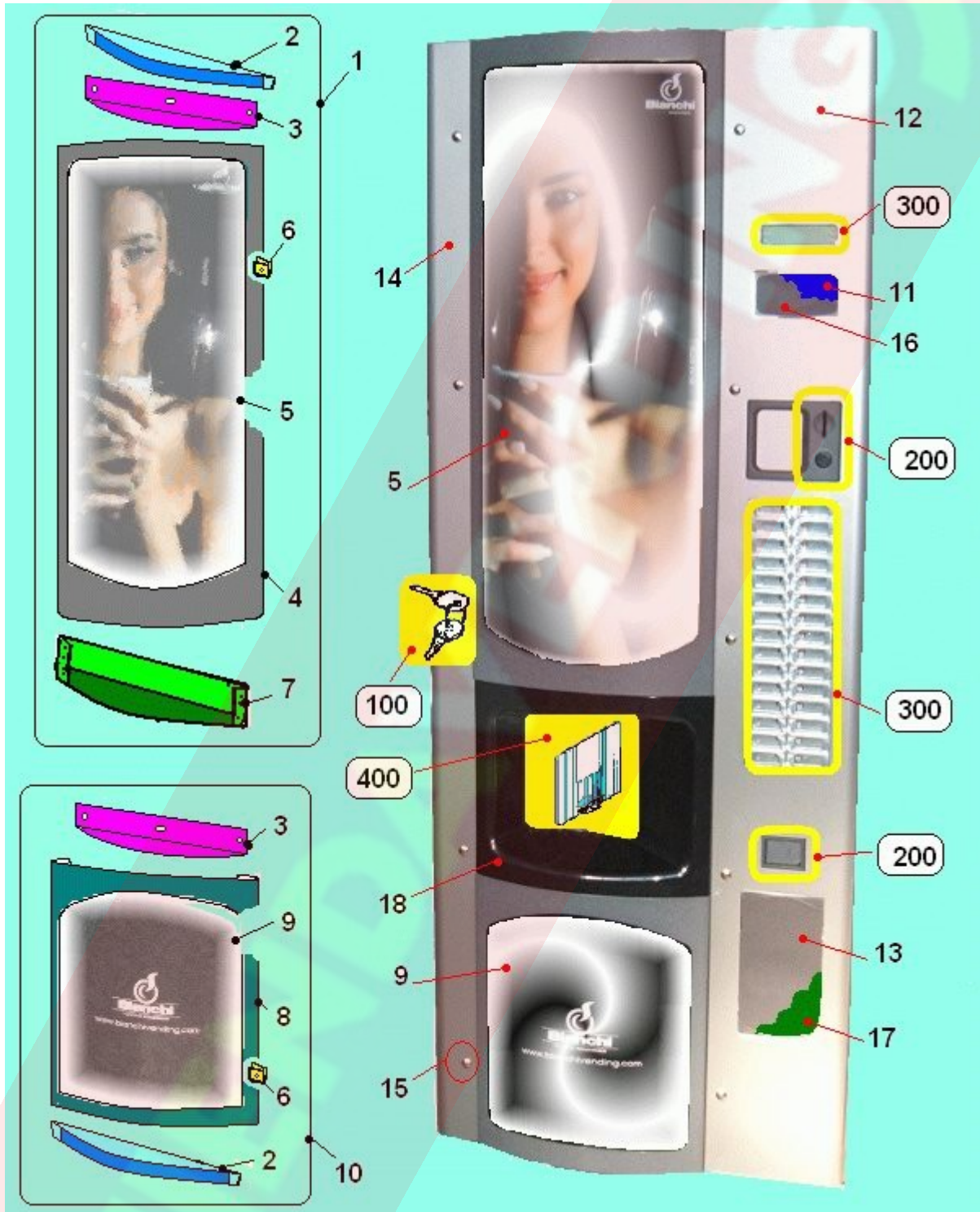

## FRONTE PORTA (829) - Detalle de los artículos

| POSICIÓN | CODIGO DE REPUESTO Accesorios                               | DESCRIPCIÓN                    | Para cada artículo principal multiplique q.ty cerca |
|----------|---|--------------------------------|---|
| 1        | 01792340  | ASS.CORNIC.LEXAN SUP.BV972 ST  |   |
| 2        | 01785411-02L30  | TAPPO CORNICE LEXAN GRAF       |   |
| 3        | 01804811  | SQUADRETTA FERMO LEXAN         |   |
| 4        | 01792411L30   | CORNICE SUPERIORE LEXAN GRAF   |   |
| 5        | 05233011-01   | LEXAN SERIGRAF.BV972 SUP       |   |
| 6        | 34511726  | PIASTRINA ELASTICA M5 SP 1     |   |
| 7        | 01785511-02L30  | BASE CORNIC.LEXAN SUP.GRAF     |   |
| 8        | 01785711L30   | CORNICE LEXAN INFER.GRAF       |   |
| 9        | 05232111  | LEXAN SERIGR.BVM951/971 INF.   |   |
| 10       | 01785610-01   | ASS.CORNICE LEXAN INFERIORE    |   |
| 11       | 05233715M00   | BACHECA SUPERIORE BVM951/971   |   |
| 12       | 01839551P54   | COVER INTERFACC STD C/BORCHIE  |   |
| 13       | 05232625M00   | BACHECA BVM951/971 H=230mm     |   |
| 14       | 01827511-01P54  | COVER LATO SERRAT.BV971 IVS IX |   |
| 15       | 32343516  | VITE TES.TON.QST 6MAX10 NIC    |   |
| 16       | 30263811  | CART.NERO X BACHECA SUPER.BVM  |   |
| 17       | 30263821  | CART.NERO X BACHECA INFER.BVM  |   |
| 18       | 05231915M09   | OBLO' CUP STATION NERO         |   |
| 100      | Vea la tabla "SERRATURA (631)" - Pág. 63                    |                                |   |
| 200      | Vea la tabla "INTRODUZIONE MONETA (647)" - Pág. 67          |                                |   |
| 300      | Vea la tabla "PULSANTIERA - VISUALIZZATORE (825)" - Pág. 69 |                                |   |
| 400      | Vea la tabla "VANO EROGAZIONE (633)" - Pág. 65              |                                |   |



Tabla: KIT ASTA SERRATURA RINFORZATA (910)

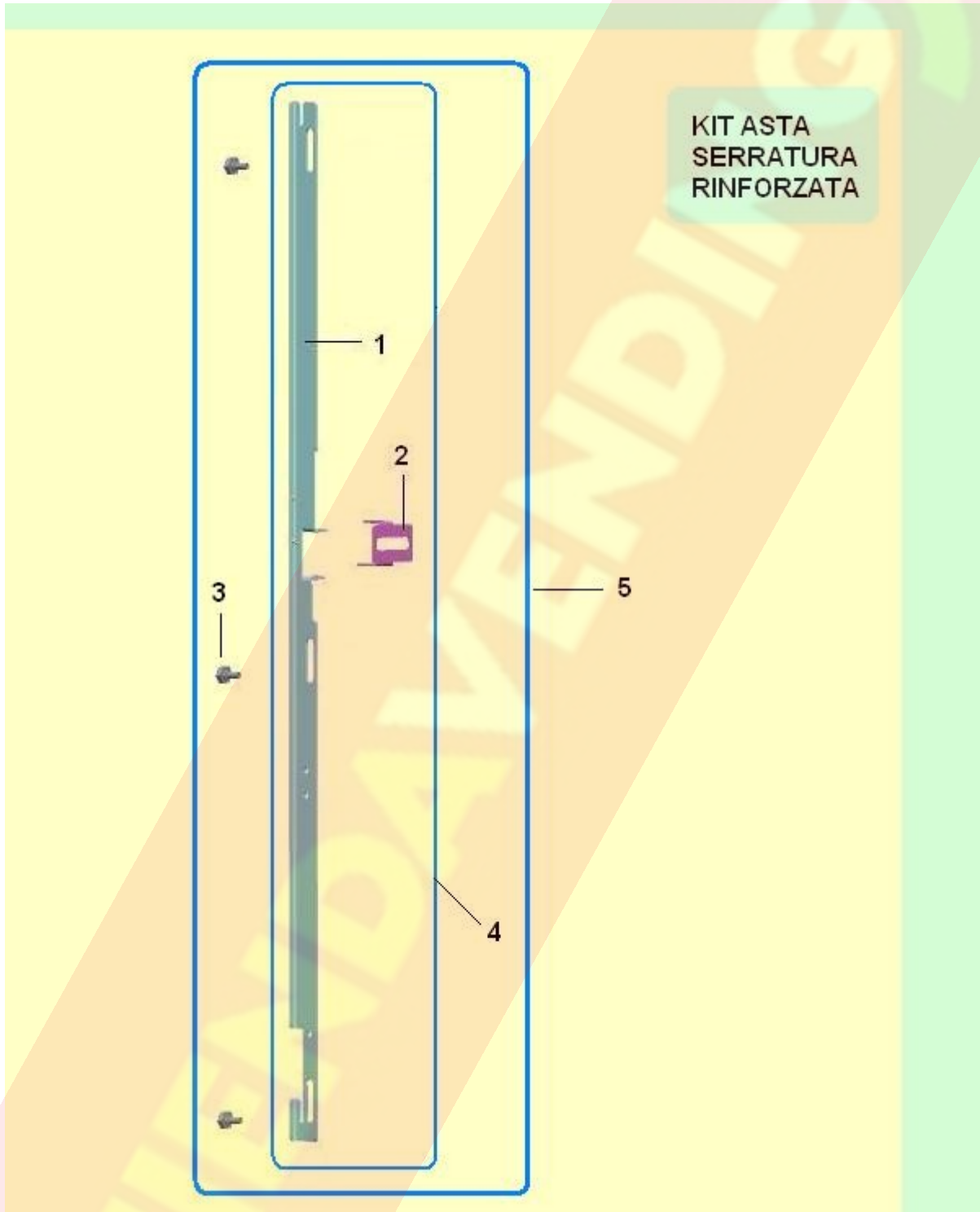

## KIT ASTA SERRATURA RINFORZATA (910) - Detalle de los artículos

| POSICIÓN | CODIGO DE REPUESTO | Accesorios | DESCRIPCIÓN                    | Para cada artículo principal<br>multiplique q.ty cerca |
|----------|--------------------|------------|--------------------------------|--|
| 1        | 01826131           |            | ASTA CHIUSURA PORTA            |  |
| 2        | 01826211-01        |            | PIASTRINA MOVIMENTO ASTA BV971 |  |
| 3        | 19055521           |            | VITE PER ASTA SERRATURA        |  |
| 4        | 01857350           |            | ASS. ASTA SERRATURA            |  |
| 5        | 41088510           |            | KIT ASTA SERRATURA RINFORZATA  |  |

TIENDA VENDING

Tablas del grupo :

- 🔗 Maquinas de Cafe
  - 📁 BVM 972 - Free Standing
    - 📁 BV972ES08GG - BVM972 E5S DC DM PD
      - 📁 CASSONE



Tabla: CASSONE (819)

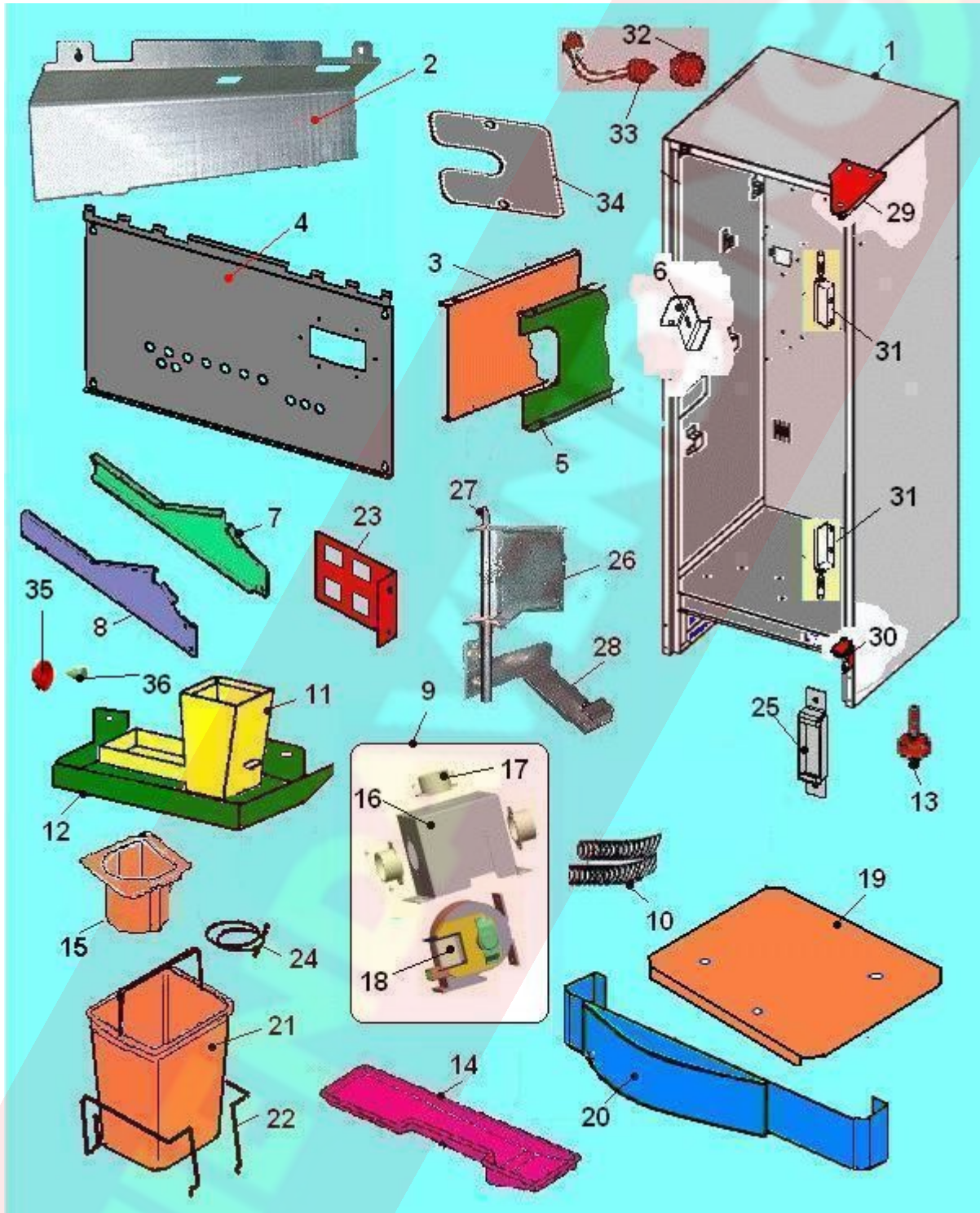

## CASSONE (819) - Detalle de los artículos

| POSICIÓN | CODIGO DE REPUESTO Accesorios | DESCRIPCIÓN                    | Para cada artículo principal multiplique q.ty cerca |
|----------|-------------------------------|--------------------------------|---|
| 1        | 01822612-03P48                | ASS. CASSONE BVM971 IVS GRAF.  |   |
| 2        | 01834121-03                   | COPERTURA SCATOLA ELETTRIC.BVM |   |
| 3        | 01834211-01                   | COPERTURA SX SUPPORTO CASSETTO |   |
| 4        | 01828321-03                   | COPERTURA POSTERIORE BV972 DC  |   |
| 5        | 01828211-01                   | COPERTURA DX SUPPORTO CASSETTO |   |
| 6        | 01828111-01                   | CARDINE SERRATURA BV971 IVS    |   |
| 7        | 01816211                      | GUIDA RECLINABILE DX BV971 IVS |   |
| 8        | 01816311                      | GUIDA RECLINABILE SX BV971 IVS |   |
| 9        | 01831320-01                   | ASS. ASPIRATORE BVM 972 SOL.   |   |
| 10       | 09031113                      | tb leviflex sz.28x33           |   |
| 11       | 05157415                      | transportador Iris             |   |
| 12       | 01828511-01                   | SUPP.RACCOGLI FONDI BV971 IVS  |   |
| 13       | 21057212                      | conj.pie regul M10x40 BVM971   |   |
| 14       | 05245615M37                   | VASCH.BV972 ESPR/SOLUB.MARR    |   |
| 15       | 05168115                      | enganche bolsa de resi iris    |   |
| 16       | 01828741-01                   | LAM.ASPIRATORE 2 VIE BV972 SOL |   |
| 17       | 05071915                      | boca x aspir.                  |   |
| 18       | 20006316                      | aspirador                      |   |
| 19       | 01841911P54                   | PROTEZIONE FONDO BV 971 IVS    |   |
| 20       | 01831112-01                   | ASS.BATTISCOPIA BV971 IVS      |   |
| 21       | 05137316                      | balde reforzado                |   |
| 22       | 07034411-01                   | MOLLA PER SECCHIO              |   |
| 23       | 01828411-01                   | PIASTRA CONNETTORI BV971 IVS   |   |
| 24       | 21056016                      | muelle                         |   |
| 25       | 01844011                      | SQUADRETTA PORTA INTERRUETTORE |   |
| 26       | 01835012-01                   | ASS.SUPP.ROTAZ.ZUCCH.UGELLI    |   |
| 27       | 12017631                      | PERNO ROTAZ. SGANCIAB. BV931   |   |
| 28       | 01834511-02                   | GUIDA x TUBI SCARICO           |   |
| 29       | 01823111                      | CARDINE SUPERIORE BVM971 IVS   |   |
| 30       | 01823011-01                   | CARDINE INFERIORE BVM971 IVS   |   |
| 31       | 21011042                      | ASS.BLOCCHETT.CERN.BV971 IVS   |   |
| 32       | 05232315M18                   | pulsador rojo                  |   |
| 33       | 26019482                      | ASS.PULS.DI SERVIZIO SENZA CA  |   |
| 34       | 01860311                      | TAPPO PER SCHIENALE BVM972     |   |
| 35       | 05116416                      | rodamiento de cajon            |   |
| 36       | 12016116                      | perno de rueda cajon           |   |

Tablas del grupo :

- 🔗 Maquinas de Cafe
  - 📁 BVM 972 - Free Standing
    - 📁 BV972ES08GG - BVM972 E5S DC DM PD
      - 📁 EROGAZIONE & DISTRIBUZIONE



Tabla: C/O COLONNA E SGANCIATORE BICCHIERI (627)



## C/O COLONNA E SGANCIATORE BICCHIERI (627) - Detalle de los artículos

| POSICIÓN | CODIGO DE REPUESTO  | Accesorios | DESCRIPCIÓN                    | Para cada artículo principal multiplique q.ty cerca |
|----------|---|------------|--------------------------------|---|
| 1        | 28011130-02   |            | C/O SGANCIATOR.BICCH.BV971 IVS |   |
| 2        | 07020711  |            | resorte para columna vasos     |   |
| 3        | 05146115M37   |            | cobertura columna vasos maròn  |   |
| 4        | 05135615  |            | disco columna vasos            |   |
| 4        | 05135615M37   |            | DISCO TAMB.SG-BICCH.MARRONE    |   |
| 5        | 28006930  |            | conj.columna vasos             |   |
| 6        | 19059311  |            | TIRANTE TAMB-BICCH.OR-SI       |   |
| 7        | 01826731-02   |            | COPERTURA SGANCIATORE BV971IVS |   |
| 8        | 01826631-01   |            | TELAIO SGANCIATORE BICCHIERI   |   |
| 9        | 09094111  |            | tubo                           |   |
| 100      | Vea la tabla "COMPONENTI SGANCIA BICCHIERI (628)" - Pág. 61 |            |                                |   |

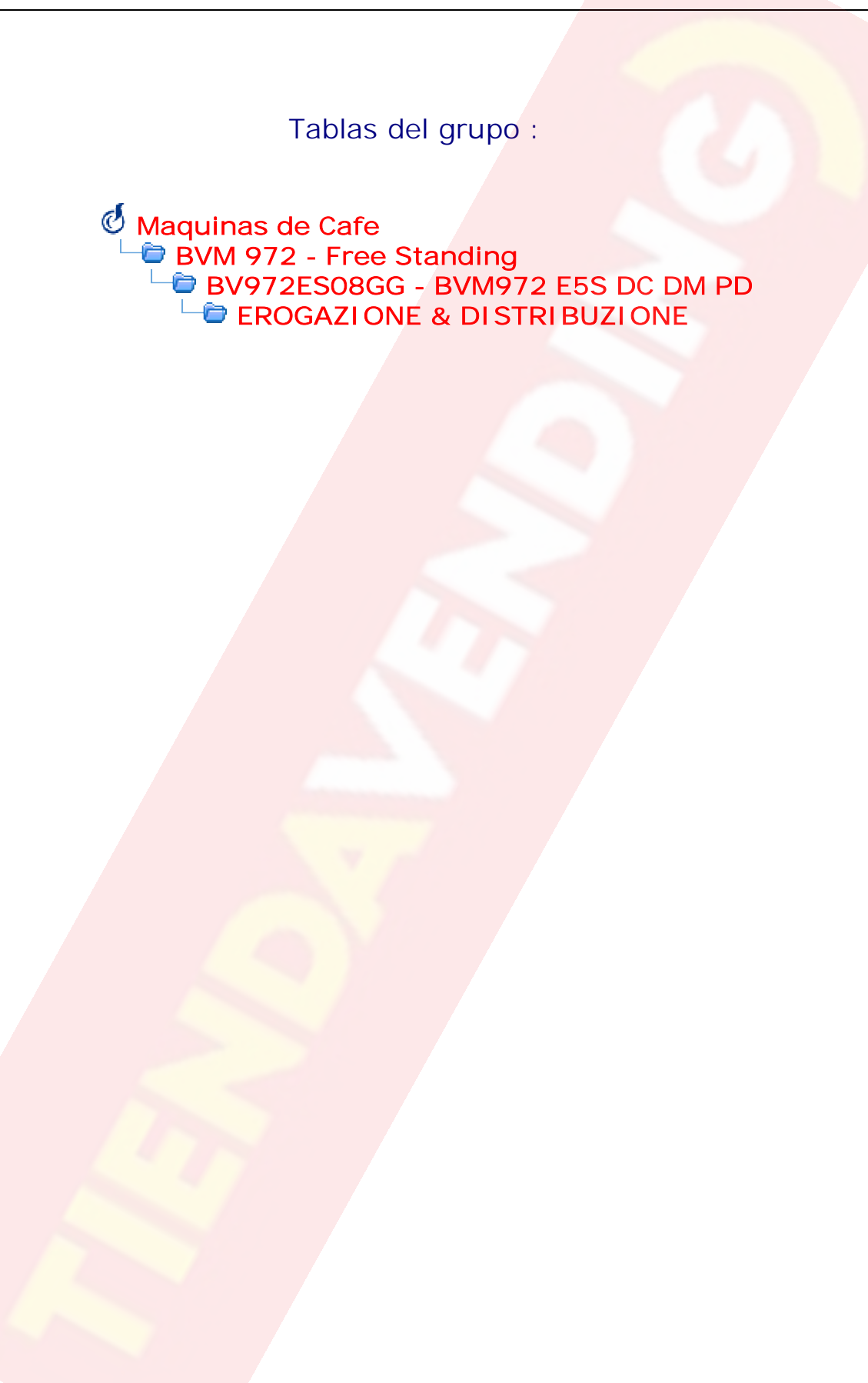
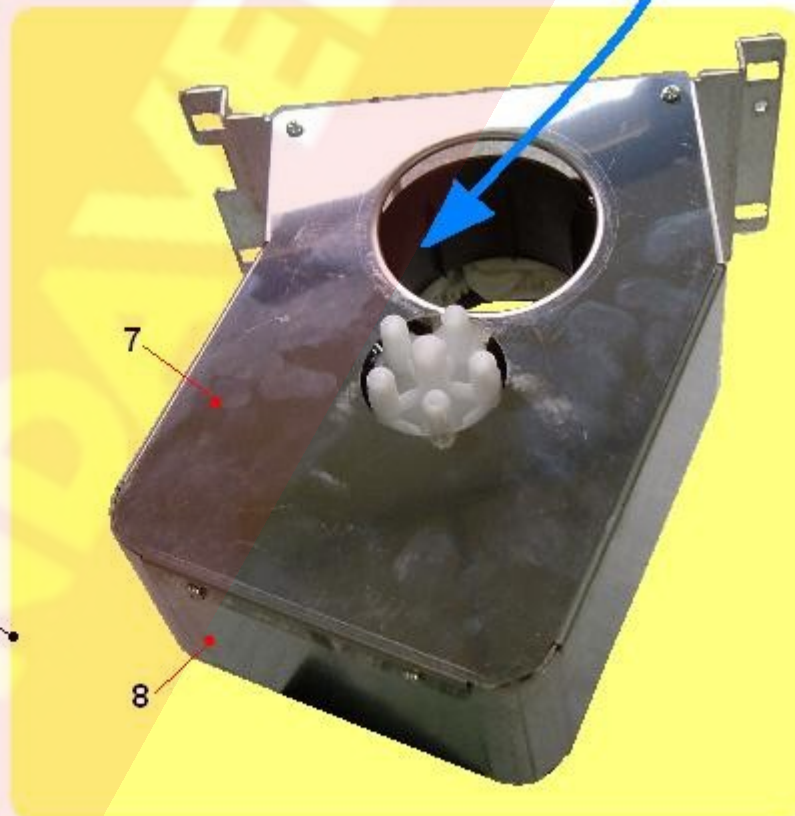
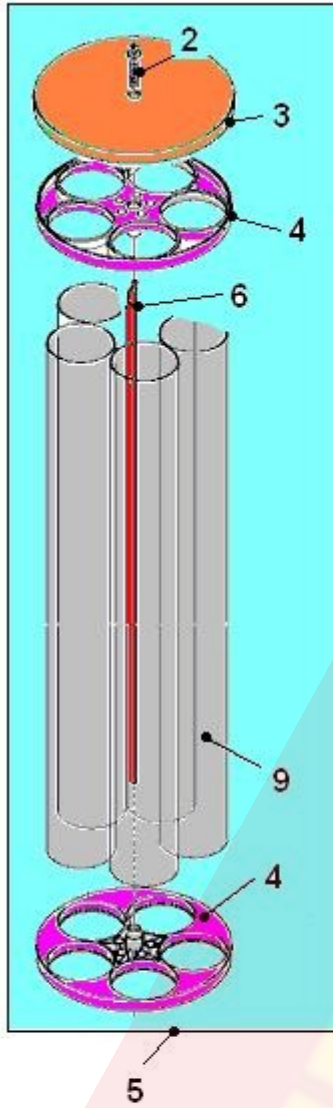
TIENDA VENDING



Tabla: ASSIEME SUPPORTO UGELLI ZUCCHERO (827)

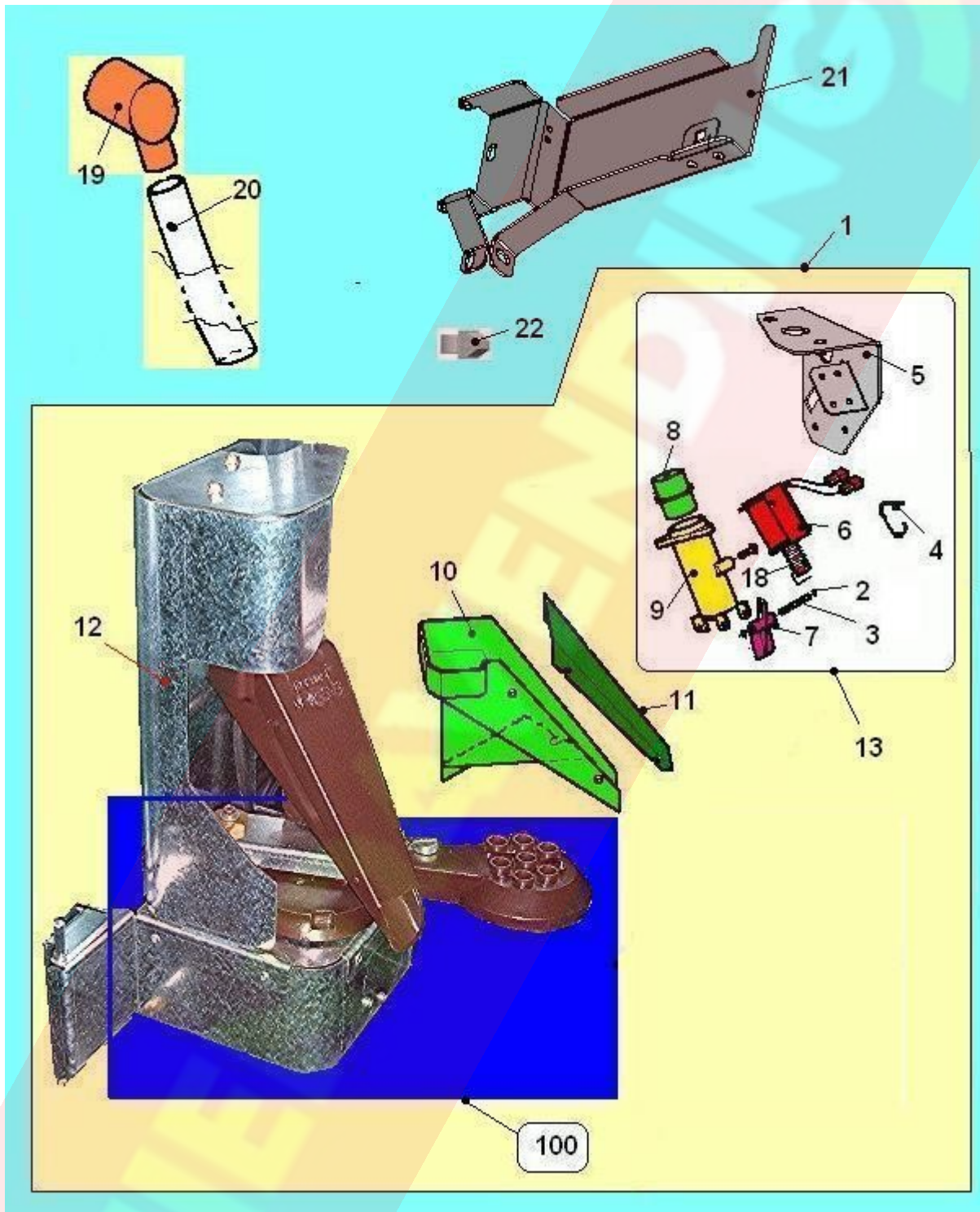

## ASSIEME SUPPORTO UGELLI ZUCCHERO (827) - Detalle de los artículos

| POSICIÓN | CODIGO DE REPUESTO Accesorios                             | DESCRIPCIÓN                     | Para cada artículo principal multiplique q.ty cerca |
|----------|---|---------------------------------|---|
| 1        | 96067460  | ASS.SUPP.UGELLI ZUCCHERO BV972  |   |
| 2        | 37000816  | anillo seeger                   |   |
| 3        | 00110823  | PERNO FULCRO LEVA               |   |
| 4        | 00110824  | anillo para electromagnete      |   |
| 5        | 01519622  | ASS.SUPP.FL-ZUCCH.ANTARES RIV   |   |
| 6        | 20008946  | electroiman 15% 24V DC          |   |
| 7        | 05123715  | leva dosificador                |   |
| 8        | 05096215  | curva para tubo azucar          |   |
| 9        | 05104715-02M37  | pestaña erogacion azucar        |   |
| 10       | 05137925  | SCIV.ZUCCH.MARRONE ANTARES      |   |
| 11       | 05138025  | COPERCH.SCIV.ZUCCH.MARR.ANT.    |   |
| 12       | 01831552-01   | ASS.SUPP. UGELLI BVM 952/972    |   |
| 13       | 96032820  | C/O SUPP. EROGAZ. ZUCCH.ANTARES |   |
| 18       | 07016911  | resorte dosificador azucar      |   |
| 19       | 05123015M37   | boca x azucar                   |   |
| 20       | 09027653  | tubo pvc cristallo 20x26        |   |
| 21       | 01835012-01   | ASS.SUPP.ROTAZ.ZUCCH.UGELLI     |   |
| 22       | 33072716  | PERNO A SCATTO RICHCO DCS-4     |   |
| 100      | Vea la tabla "COMPONENTI SUPPORTO UGELLI (603)" - Pág. 59 |                                 |   |

Tabla: DISTRIBUTORE PALETTE (918)

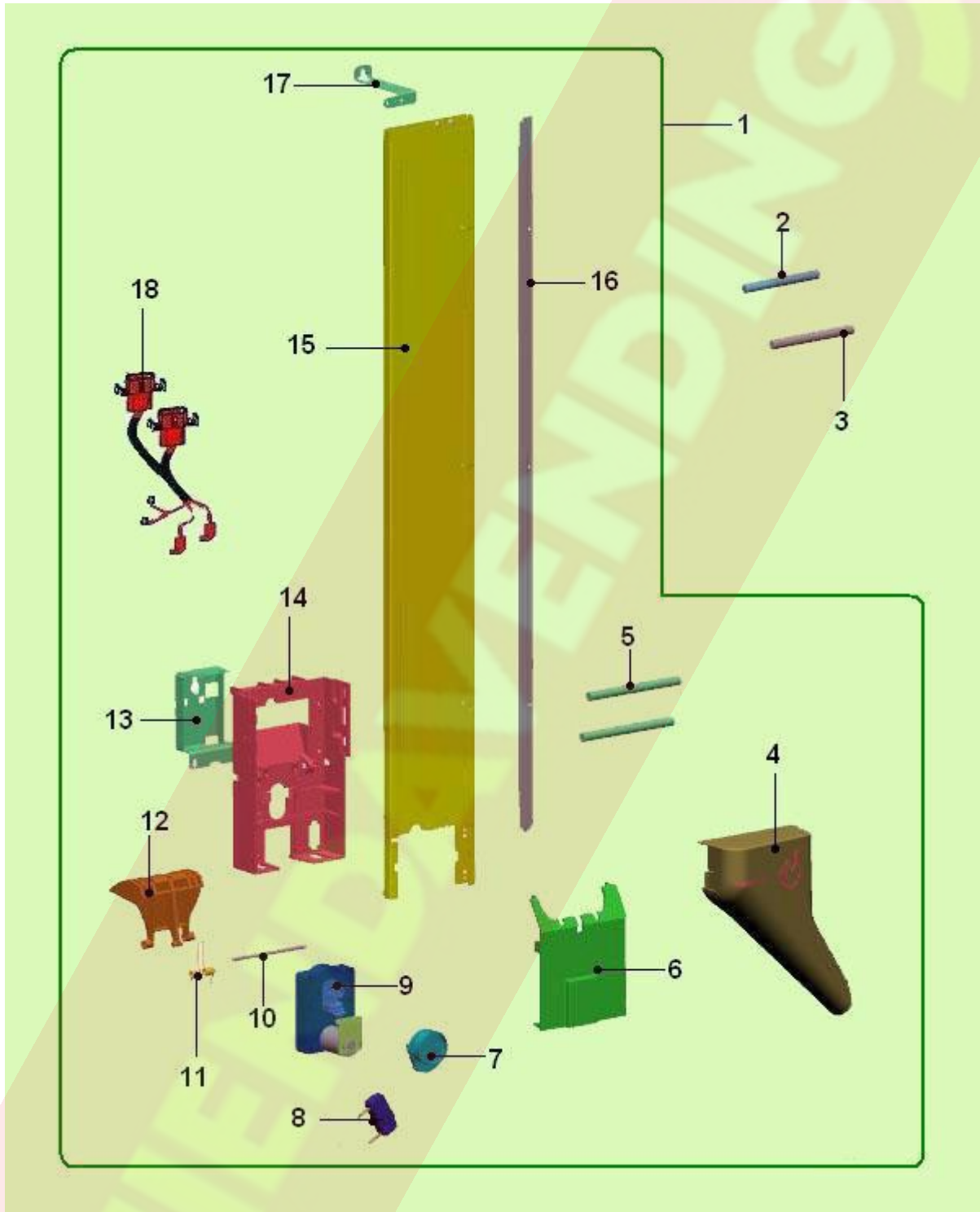

## DISTRIBUTORE PALETTE (918) - Detalle de los artículos

| POSICIÓN | CODIGO DE REPUESTO Accesorios | DESCRIPCIÓN                    | Para cada artículo principal multiplique q.ty cerca |
|----------|-------------------------------|--------------------------------|---|
| 1        | 43029910-04                   | C/O PALET.971 90/105 IVS COMPL |   |
| 2        | 12004611-01                   | PESO X CUCCHIAINI L=90mm       |   |
| 3        | 12013611-02                   | peso para paletinas 105        |   |
| 4        | 05241415-02M00                | SCIVOLO PALETT.CADUTA DX BV951 |   |
| 5        | 12047111                      | RULLO PER PALETTIERA           |   |
| 6        | 05241615M09                   | COPERC.SCATOLA PALETTIERA NERO |   |
| 7        | 05241515-01M00                | CAMMA MOVIMENTAZ. PALETTIERA   |   |
| 8        | 26029626                      | microint. bt pres.agua v.k     |   |
| 9        | 20020926                      | MOTORIDUTT.24DC 25 RPM C/SPALL |   |
| 10       | 19059811-01                   | ALBERINO ESPULS.PALET.IRIS     |   |
| 11       | 07021731                      | MOLLA PAL.D1,3 90/105 C/PIED   |   |
| 12       | 05149015-01M37                | expulsor paletinas maron iris  |   |
| 13       | 01839912                      | TELAIO DISTR.PAL.C/INSERTI IVS |   |
| 14       | 05241315-01M09                | SCATOLA PALETTIERA NERO        |   |
| 15       | 01837711-03                   | CONTENITORE PALETTE L=90-105   |   |
| 16       | 01837811-03P54                | PARATIA DI RIDUZ.XPALETTE L=90 |   |
| 17       | 01840011                      | SQUADRETTAxCONTENIT.PALETT.IVS |   |
| 18       | 22180112                      | CABL.PALET.PLS 90/105 BV951/71 |   |

Tablas del grupo :

- 🔗 Maquinas de Cafe
  - 📁 BVM 972 - Free Standing
    - 📁 BV972ES08GG - BVM972 E5S DC DM PD
      - 📁 C/O ESPRESSO



Tabla: CALDERA(8)



## CALDERA(8) - Detalle de los artículos

| POSICIÓN | CODIGO DE REPUESTO | Accesorios | DESCRIPCIÓN                    | Para cada artículo principal<br>multiplique q.ty cerca |
|----------|--------------------|------------|--------------------------------|--|
| 1        | 85002810-01        |            | ASS.CALD.24VDC DOPPIA SI-OR    |  |
| 2        | 01599411-02        |            | MOLLETTA X TERMOREGOLAT.       |  |
| 3        | 25020516           |            | clixon a apert rap ty6o 11     |  |
| 4        | 25020616-01        |            | clixon a rearme man. ty6or     |  |
| 5        | 29004312-01        |            | resistencia inox               |  |
| 6        | 26050826-01        |            | sensor de temp. con NTC+conect |  |
| 7        | 18002516           |            | guarnic. rame d.10             |  |
| 8        | 04035326           |            | codo art.237 6-1/8             |  |
| 9        | 05143815           |            | guarnic. caldera expreso       |  |
| 10       | 13008011           |            | cuerpo caldera grupo cafe      |  |
| 11       | 04040316           |            | valvula de descarga + or 1     |  |
| 12       | 25020856           |            | electrovalvula 3 vie 24v dc    |  |
| 13       | 23020626           |            | lengueta macho 6.3x0.8         |  |
| 14       | 18007011           |            | arandela freno piston ot58     |  |
| 15       | 32055536           |            | tornillo te 4ma x 16 ix.       |  |
| 16       | 35153426           |            | arandela elast.d.4,3 ix.       |  |
| 17       | 32068416           |            | VITE TCEI 4 MA X 40 ZNB        |  |
| 18       | 32067916           |            | TCEI 4MAX20 tuerca             |  |
| 19       | 35160316           |            | arandela dent.d.4,2            |  |
| 20       | 32050516           |            | tornillo 4 MAX10 c/r zin       |  |
| 21       | 32068116           |            | tornillo tcei 4ma x 25 pf.     |  |
| 22       | 35157616           |            | arandela plana ø 4,3 ac.       |  |
| 23       | 32025116           |            | tornillo tc 3ma x 5 zin.       |  |
| 24       | 19056011           |            | perno fijac. grupo             |  |

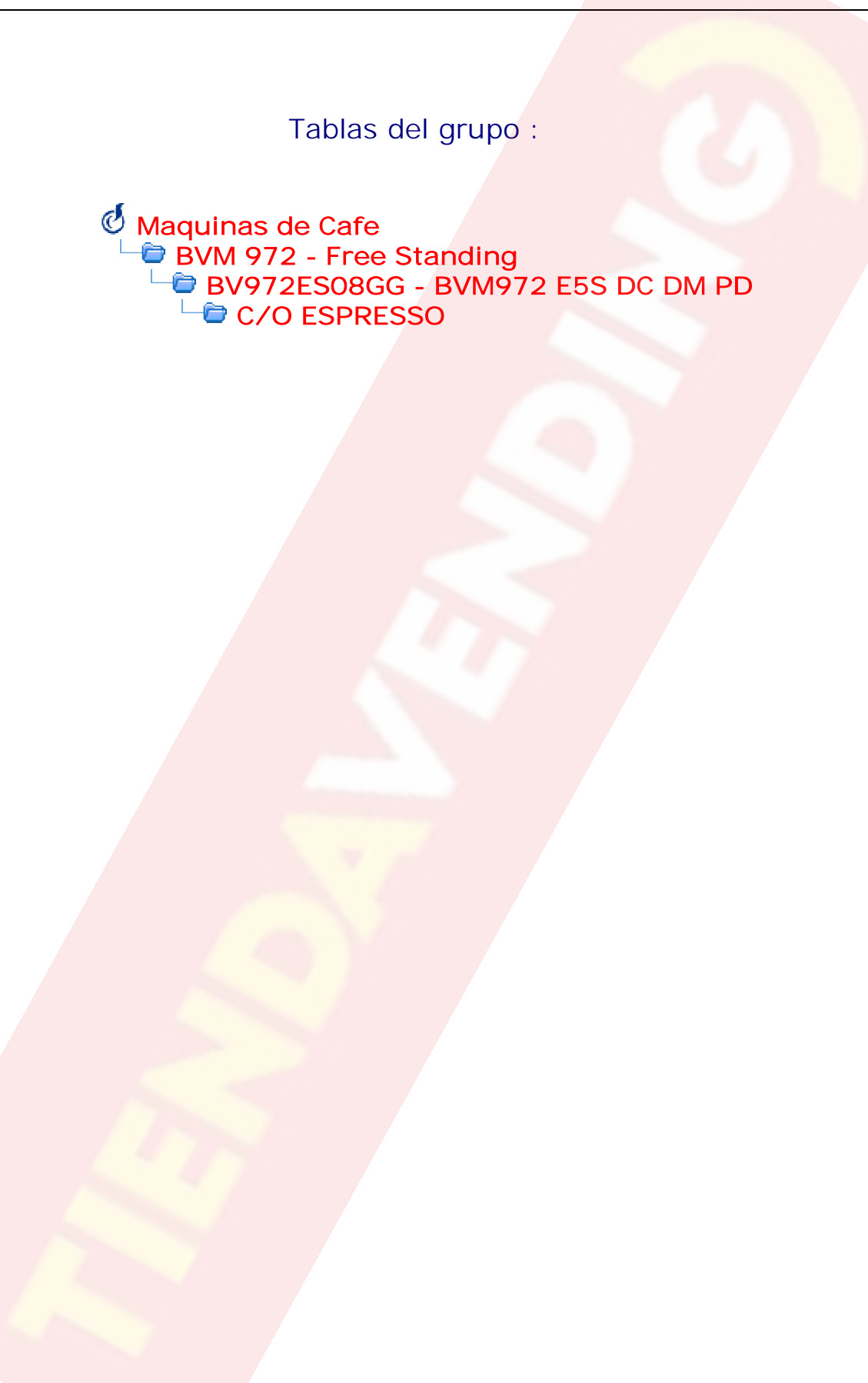
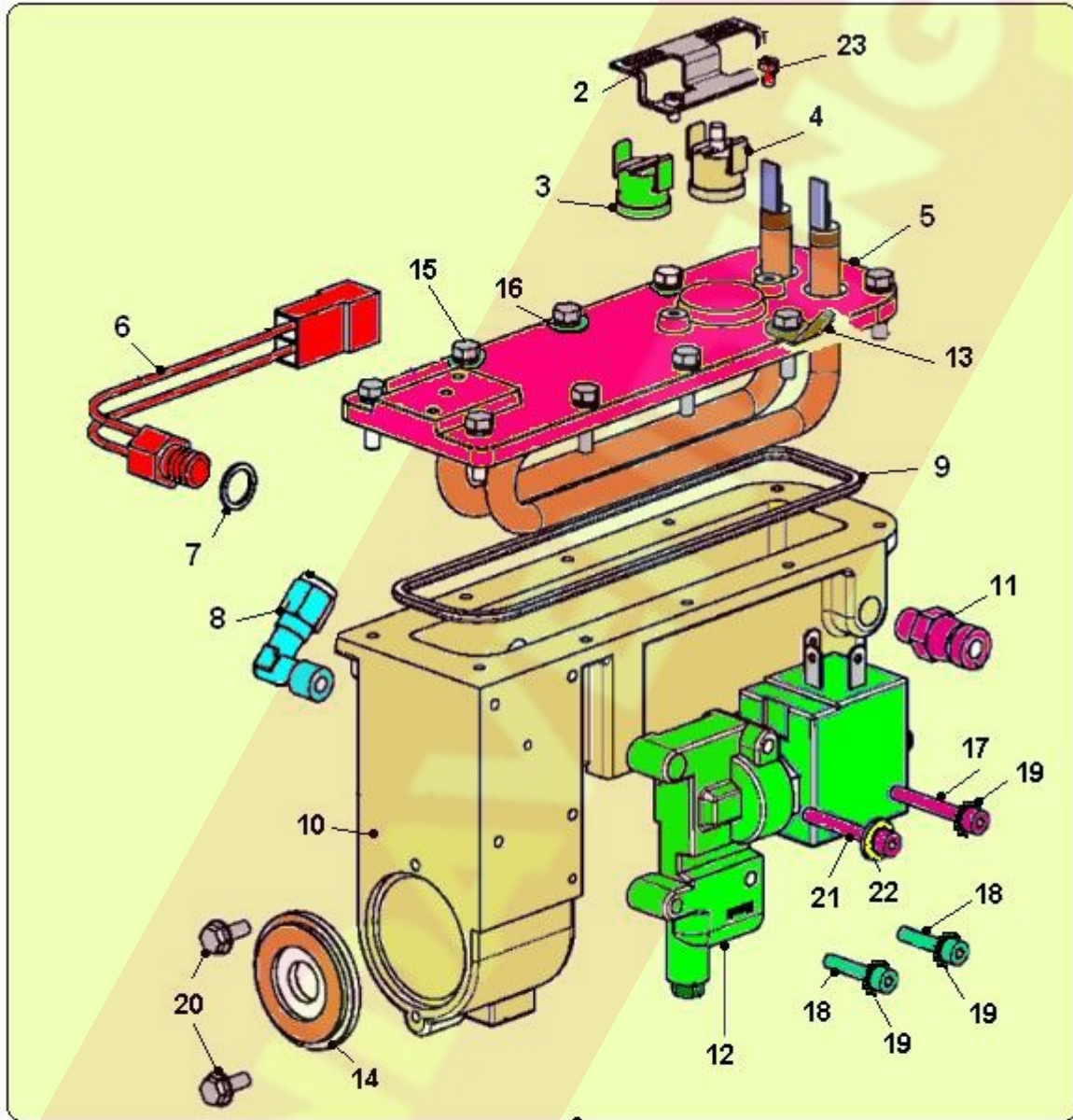
Tabla: GRUPO CAFE' PLASTICO(1)

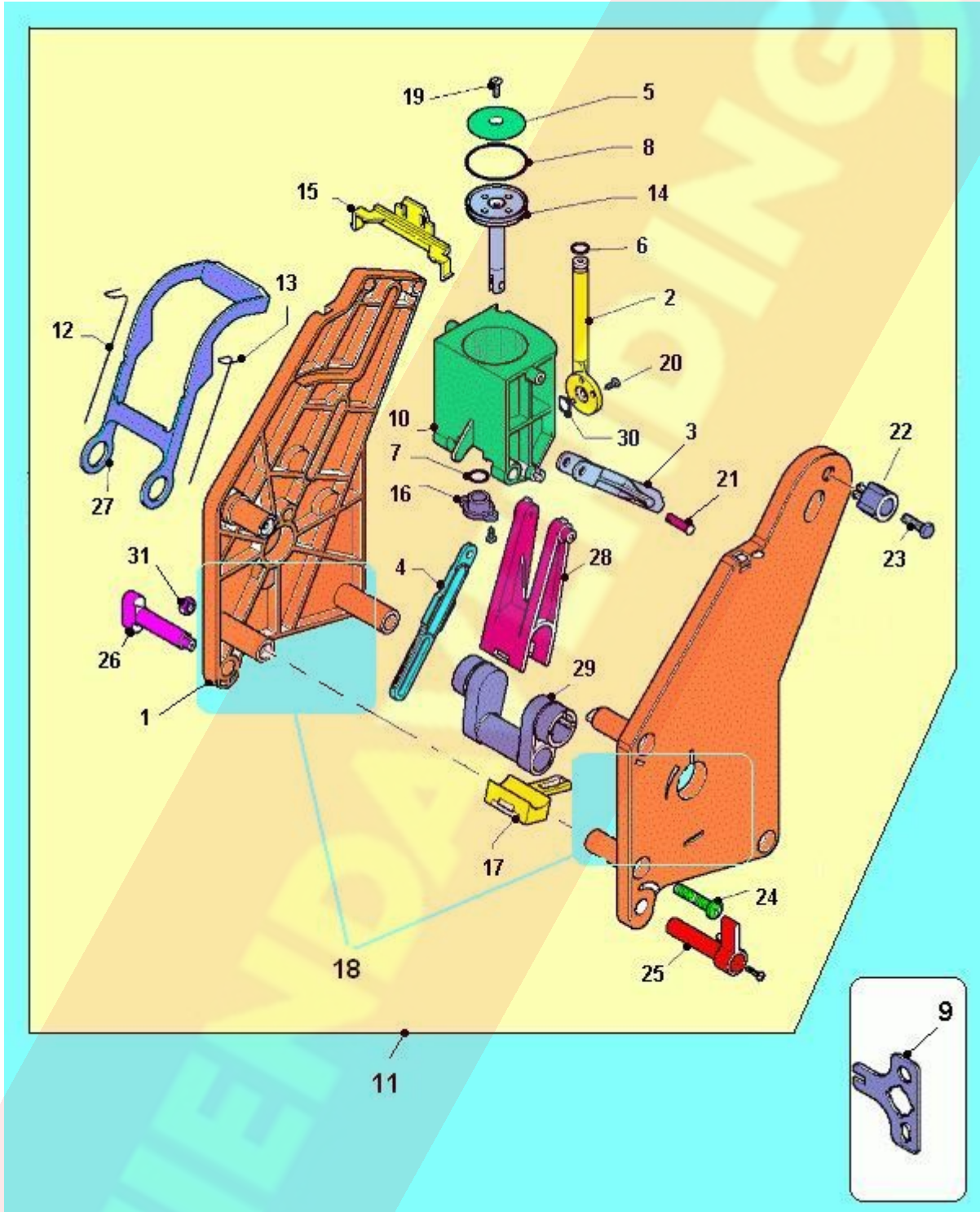



## GRUPO CAFE' PLASTICO(1) - Detalle de los artículos

| POSICIÓN | CODIGO DE REPUESTO | Accesorios | DESCRIPCIÓN                    | Para cada artículo principal multiplique q.ty cerca |
|----------|--------------------|------------|--------------------------------|---|
| 1        | 05106415-01        |            | espalda trasera                |   |
| 2        | 05106815-01        |            | tubito para vaso               |   |
| 3        | 05148315           |            | vara de filtro                 |   |
| 4        | 05107415           |            | brazo de traccion              |   |
| 5        | 16012021           |            | filtro x grupo cafe            |   |
| 6        | 36351316           |            | guarn.X-ring pip.gr.cafè       |   |
| 7        | 36211916           |            | guarnic. OR 2037 viton         |   |
| 8        | 36206316           |            | O-RING 2112 VITON              |   |
| 9        | 01475411-01        |            | llave para rotacion grupo      |   |
| 10       | 05106615-01        |            | vaso                           |   |
| 11       | 95007420-01        |            | conj. grupo cafe plastico      |   |
| 12       | 07017911           |            | resorte derecha                |   |
| 13       | 07017921           |            | resorte izquierda              |   |
| 14       | 05161215           |            | eje expulsión gr. café         |   |
| 15       | 05133515           |            | distanciales                   |   |
| 16       | 05106715           |            | anillo para vaso               |   |
| 17       | 05107215           |            | estribo                        |   |
| 18       | 43123910           |            | conj espalda delantera/trasera |   |
| 19       | 32035236           |            | tornillo tsp 3ma x 6 ix.       |   |
| 20       | 32222827           |            | VITE A/F 2,9X 9,5 IX S/PUNTA   |   |
| 21       | 05107515           |            | brazo de traccion              |   |
| 22       | 05109515           |            | sujetador                      |   |
| 23       | 32090636           |            | tornillo te 5ma x 18 ix.       |   |
| 24       | 32060936           |            | tornillo tc 4ma x 20 ix.       |   |
| 25       | 05107815           |            | leva de bloqueo                |   |
| 26       | 05107915           |            | brazo de bloqueo               |   |
| 27       | 05107015           |            | espatula                       |   |
| 28       | 05107115           |            | biella                         |   |
| 29       | 05107615           |            | manija                         |   |
| 30       | 36210916           |            | guarnic. OR 2021 viton         |   |
| 31       | 34110316           |            | tuerca autobl.5ma zin.         |   |

Tabla: MOTORI DUTTORE GRUPPO CAFFE' (483)

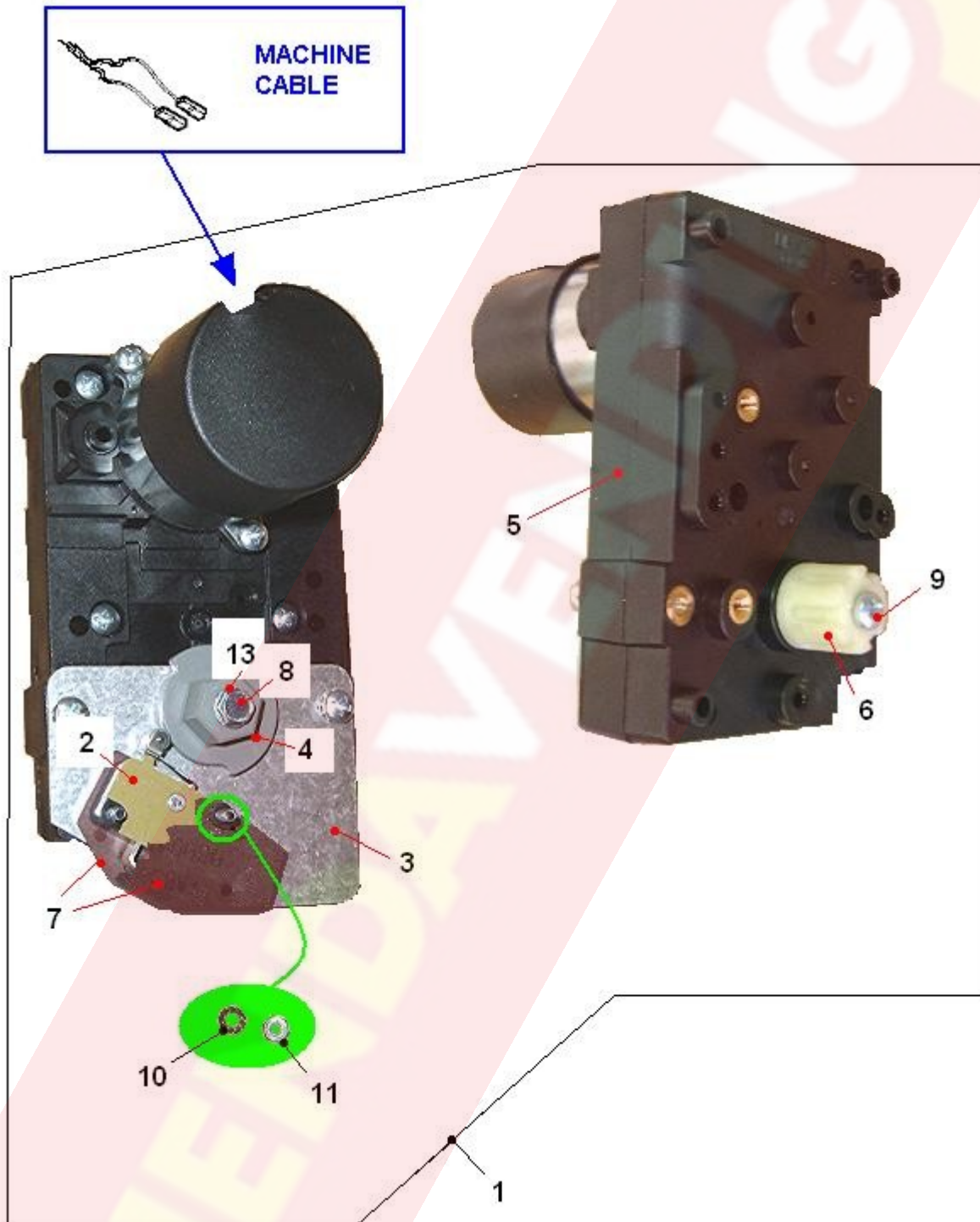

## MOTORI DUTTORE GRUPPO CAFFE' (483) - Detalle de los artículos

| POSICIÓN | CODIGO DE REPUESTO | Accesorios | DESCRIPCIÓN                    | Para cada artículo principal<br>multiplique q.ty cerca |
|----------|--------------------|------------|--------------------------------|--|
| 1        | 20016810-03        |            | junt.motoreductor sin cabl.24V |  |
| 2        | 26005126           |            | micro con rueda xgm281s20      |  |
| 3        | 01484212           |            | estribo                        |  |
| 4        | 05110915M37        |            | CAMMA ROTAZ. GRUPPO MARRONE    |  |
| 5        | 20014946-02        |            | MOTORID. 24V DC 11-12 R S/CABL |  |
| 6        | 41081216           |            | codo en plastico gr/café       |  |
| 7        | 08004111           |            | aislante micro                 |  |
| 8        | 32050516           |            | tornillo 4 Mx10 c/r zin        |  |
| 9        | 32061016           |            | tornillo TC M4x25              |  |
| 10       | 35160216           |            | arandela dent.d.3,2            |  |
| 11       | 34102716           |            | tuerca es.M3                   |  |
| 13       | 35160316           |            | arandela dent.d.4,2            |  |

TIENDA VENDING

Tabla: ASS. DOSATORE CAFFE' (539)

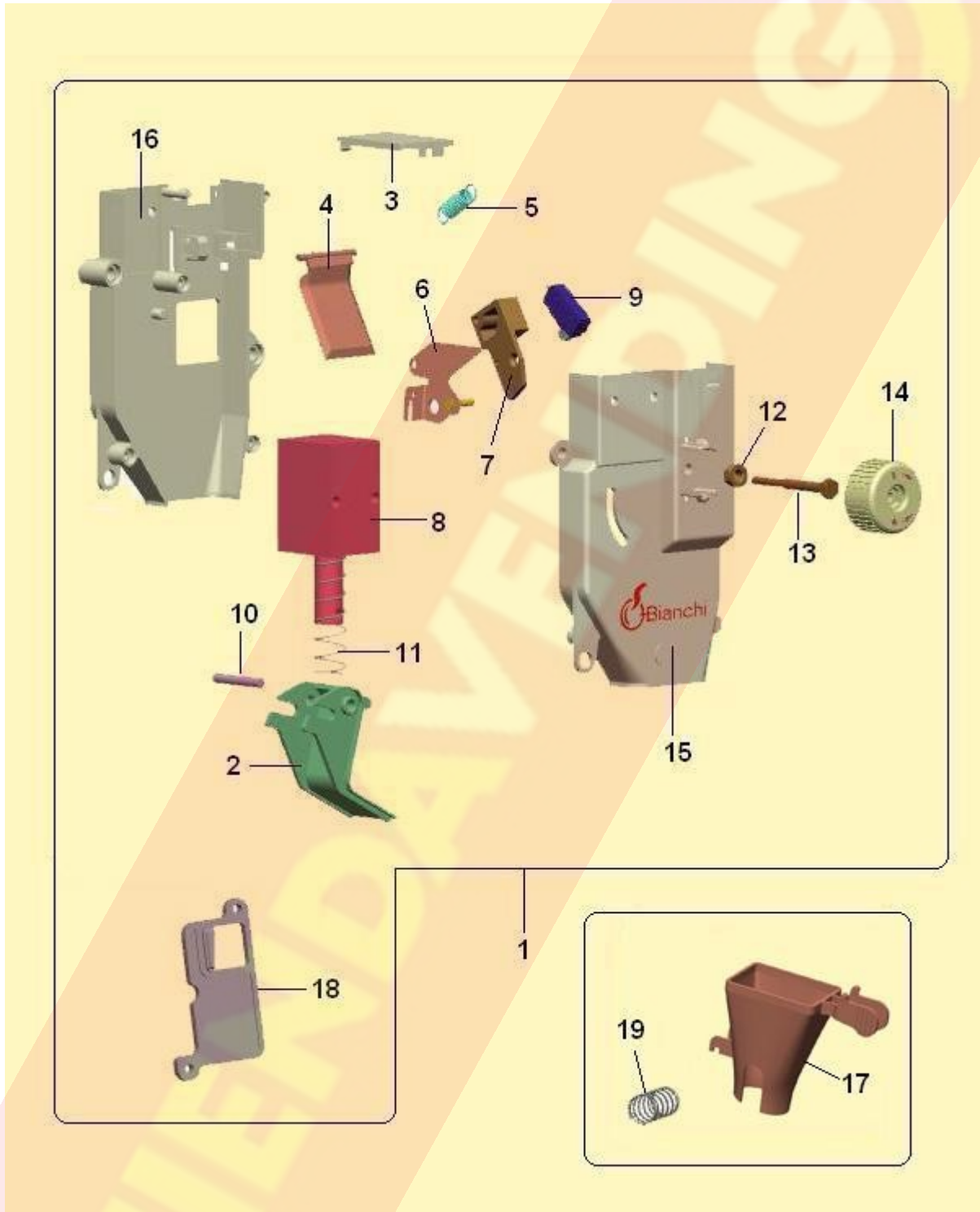

## ASS. DOSATORE CAFFE' (539) - Detalle de los artículos

| POSICIÓN | CODIGO DE REPUESTO | Accesorios | DESCRIPCIÓN                    | Para cada artículo principal multiplique q.ty cerca |
|----------|--------------------|------------|--------------------------------|---|
| 1        | 43002410-02        |            | conj. dosificador c/distancial |   |
| 2        | 05135115-01        |            | caj.basculante dos. café       |   |
| 3        | 05135025           |            | tapa dosador café              |   |
| 4        | 05135315           |            | PARAT.MOBILE DOS.CAFFE         |   |
| 5        | 07020611           |            | MOLLA X SQUAD.MICRO            |   |
| 6        | 01586212-02        |            | SQUAD.MICRO C/PRG              |   |
| 7        | 05154615           |            | SUPP. MICRO DOS-CAFFE' C/POM   |   |
| 8        | 20019146-01        |            | electroimagnete 5% 24V DC      |   |
| 9        | 26029616           |            | micro a retenc. cablato        |   |
| 10       | 33051716           |            | SPINA CILINDRICA 4X25 IX       |   |
| 11       | 07020511-01        |            | resorte para electroiman       |   |
| 12       | 34115316           |            | tuerca con arandela M4         |   |
| 13       | 19058911           |            | tornillo regol. micro interr   |   |
| 14       | 05135215           |            | sujetador regulac.dosis        |   |
| 15       | 05134815           |            | cobertura ant.                 |   |
| 16       | 05134925           |            | cobertura pos.                 |   |
| 17       | 05135425           |            | IMBUTO CAFFE TAGLIATO X 2 MAC  |   |
| 18       | 05155615-01        |            | distancial dosador             |   |
| 19       | 07020911           |            | resorte de caída               |   |

Tabla: ASSIEME PISTONE (822)

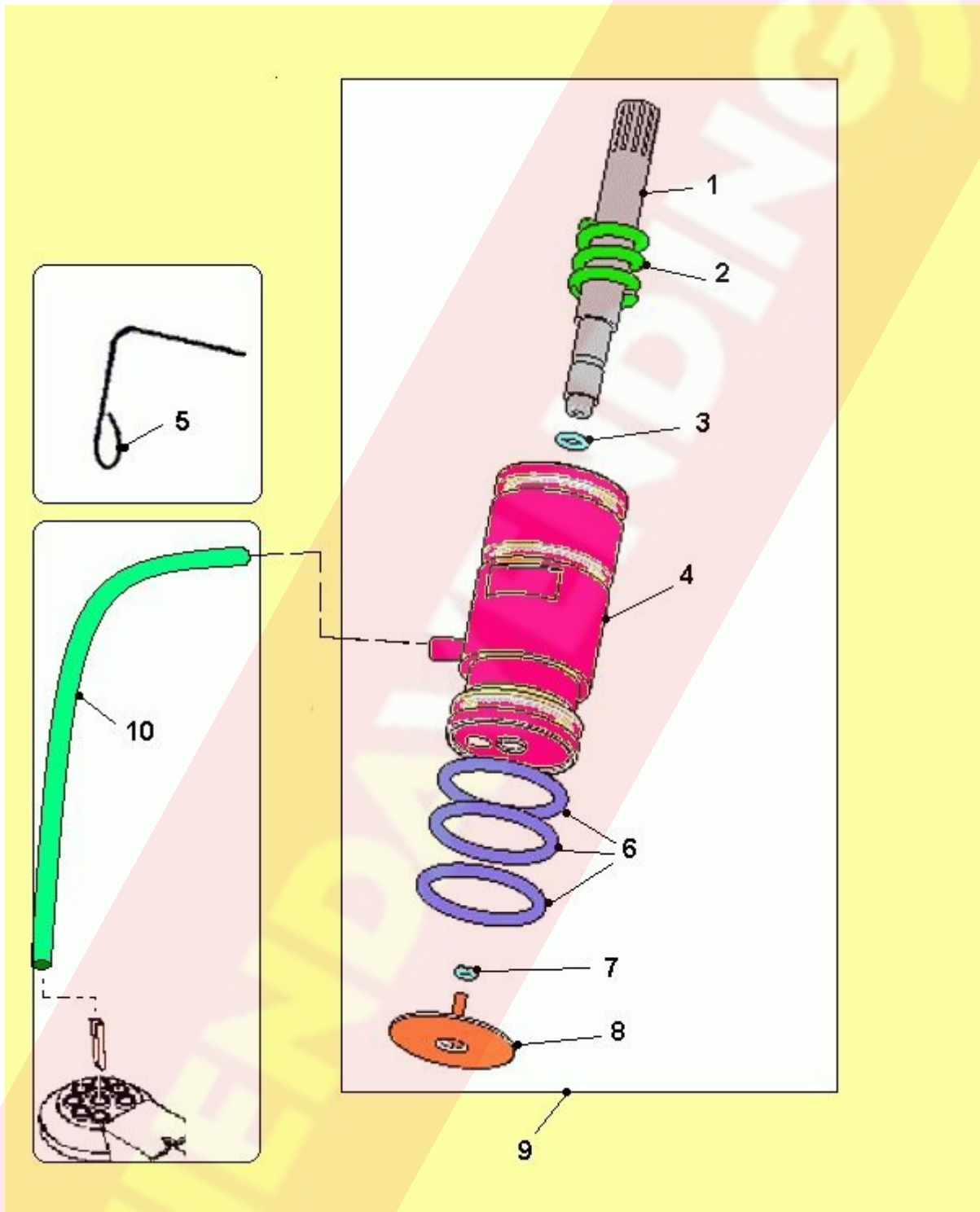

## ASSIEME PISTONE (822) - Detalle de los artículos

| POSICIÓN | CODIGO DE REPUESTO | Accesorios | DESCRIPCIÓN                | Para cada artículo principal multiplique q.ty cerca |
|----------|--------------------|------------|----------------------------|---|
| 1        | 05107725           |            | sujetador para filtro pist |   |
| 2        | 07017611           |            | resorte x piston           |   |
| 3        | 36210916           |            | guarnic. OR 2021 viton     |   |
| 4        | 05148032-01        |            | piston grupo bianchi       |   |
| 5        | 07017511           |            | eje frena piston           |   |
| 6        | 36211816           |            | guarnic. OR 4112 viton     |   |
| 7        | 36212116           |            | guarnic. OR 2010 viton     |   |
| 8        | 16014812           |            | conj. filtro               |   |
| 9        | 05138130-01        |            | junt.piston grupo caffè    |   |
| 10       | 09087873M57        |            | TUBO SILICONE 3x6 NERO AM  |   |

TIENDA VENDING

Tabla: TRAMOGGIA CAFFE' DX-SX (818)

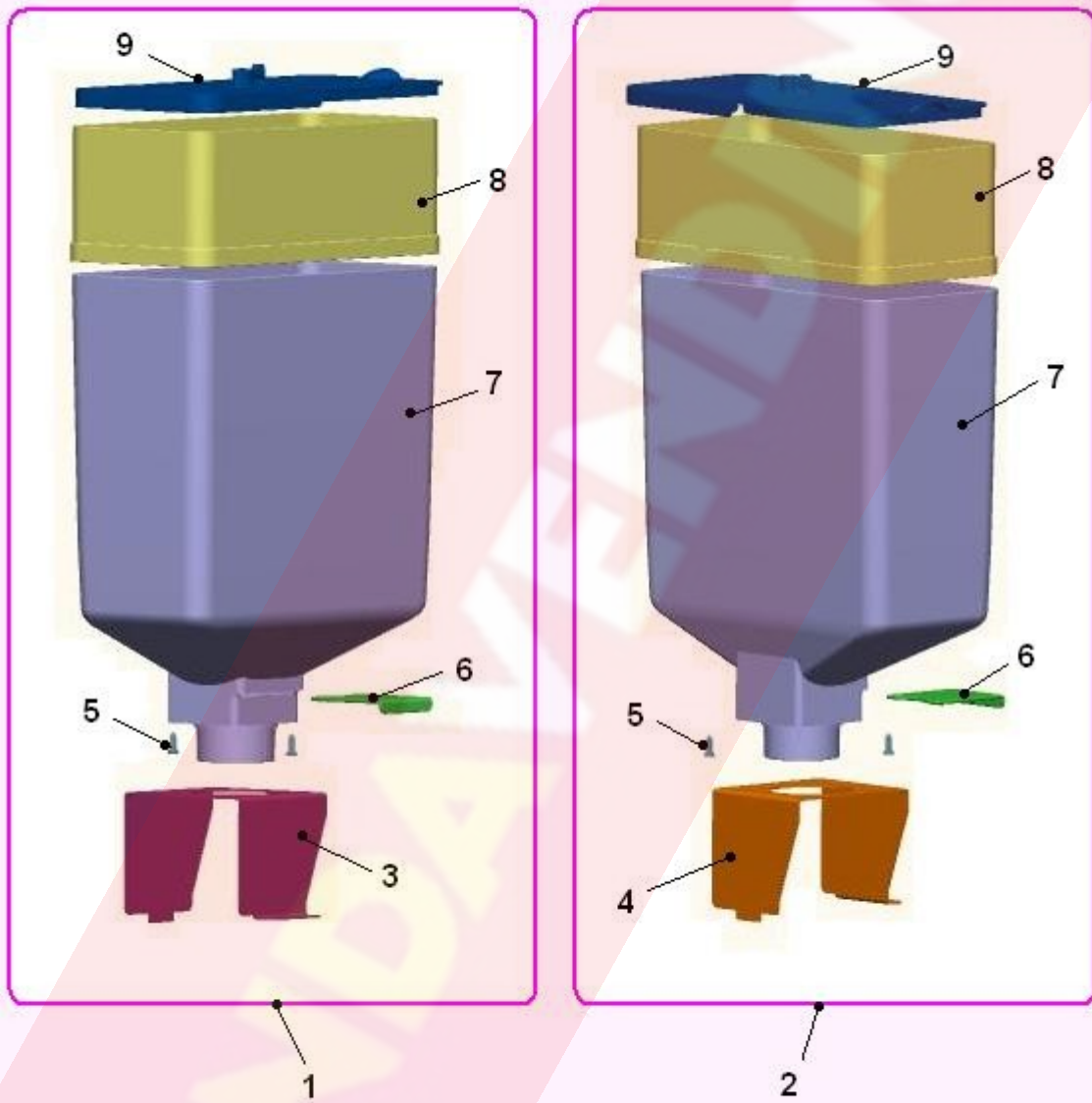



## TRAMOGGIA CAFFE' DX-SX (818) - Detalle de los artículos

| POSICIÓN | CODIGO DE REPUESTO | Accesorios | DESCRIPCIÓN                    | Para cada artículo principal<br>multiplique q.ty cerca |
|----------|--------------------|------------|--------------------------------|--|
| 1        | 05251220           |            | ASS.TRAMOGG.CAFFE SX BV972 DM  |  |
| 2        | 05251210           |            | ASS.TRAMOGG.CAFFE DX BV972 DM  |  |
| 3        | 01871921           |            | SUPP. SX x TRAMOGGIA BVM       |  |
| 4        | 01871911           |            | SUPP. DX x TRAMOGGIA BVM       |  |
| 5        | 32010336           |            | VITE A/F 4,0x12 TCB UNI 9707   |  |
| 6        | 05147915           |            | PARATIA TRAMOG.CAF.SPRINT      |  |
| 7        | 05251315M00        |            | TRAMOGGIA CAFFE BVM972         |  |
| 8        | 05256315M00        |            | PROLUNGA TRAMOGGIA CAFFE BVM   |  |
| 9        | 05255015M00        |            | COPERCH. TRAMOGGIA DX-SX BV972 |  |

TIENDA VENTURA

Tabla: C/O MACINA-DOSATORE (817)

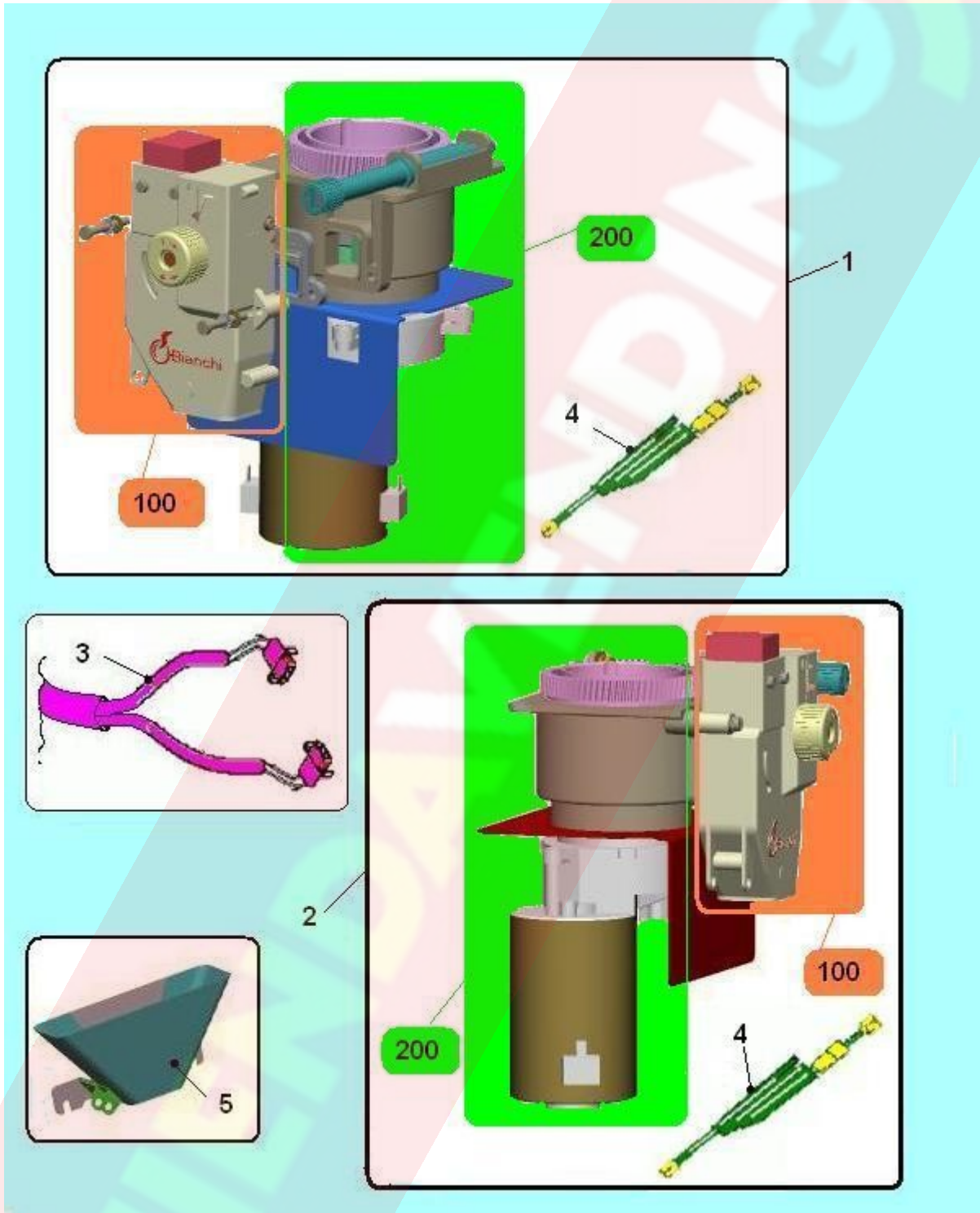

## C/O MACINA-DOSATORE (817) - Detalle de los artículos

| POSICIÓN | CODIGO DE REPUESTO                                  | Accesorios | DESCRIPCIÓN                    | Para cada artículo principal<br>multiplique q.ty cerca |
|----------|---|------------|--------------------------------|--|
| 1        | 96057650  |            | C/O MACINADOS. CAFFE SX BVM972 |  |
| 2        | 96057640  |            | C/O MACINADOS. CAFFE DX BVM972 |  |
| 3        | 22175712-01   |            | CABLAGGIO DOPPIO MACININO      |  |
| 4        | 22126622  |            | PROTEZ.MOT.MAC. AMETEK FAST4,8 |  |
| 5        | 01815112  |            | ASS.CONVOGLIATORE CAFFE' 2 MAC |  |
| 100      | Vea la tabla "ASS. DOSATORE CAFFE' (539)" - Pág. 26 |            |                                |  |
| 200      | Vea la tabla "MOLINO (816)" - Pág. 71               |            |                                |  |

Tablas del grupo :

- 🔗 Maquinas de Cafe
  - 📁 BVM 972 - Free Standing
    - 📁 BV972ES08GG - BVM972 E5S DC DM PD
      - 📁 C/O ESPRESSO - SOLUBILI

TIENDA VENDING

Tabla: C/O SUPP. MACINADOSATORE-MOTORI DUTTORI SCATOLE DOSATRICI ( 815)

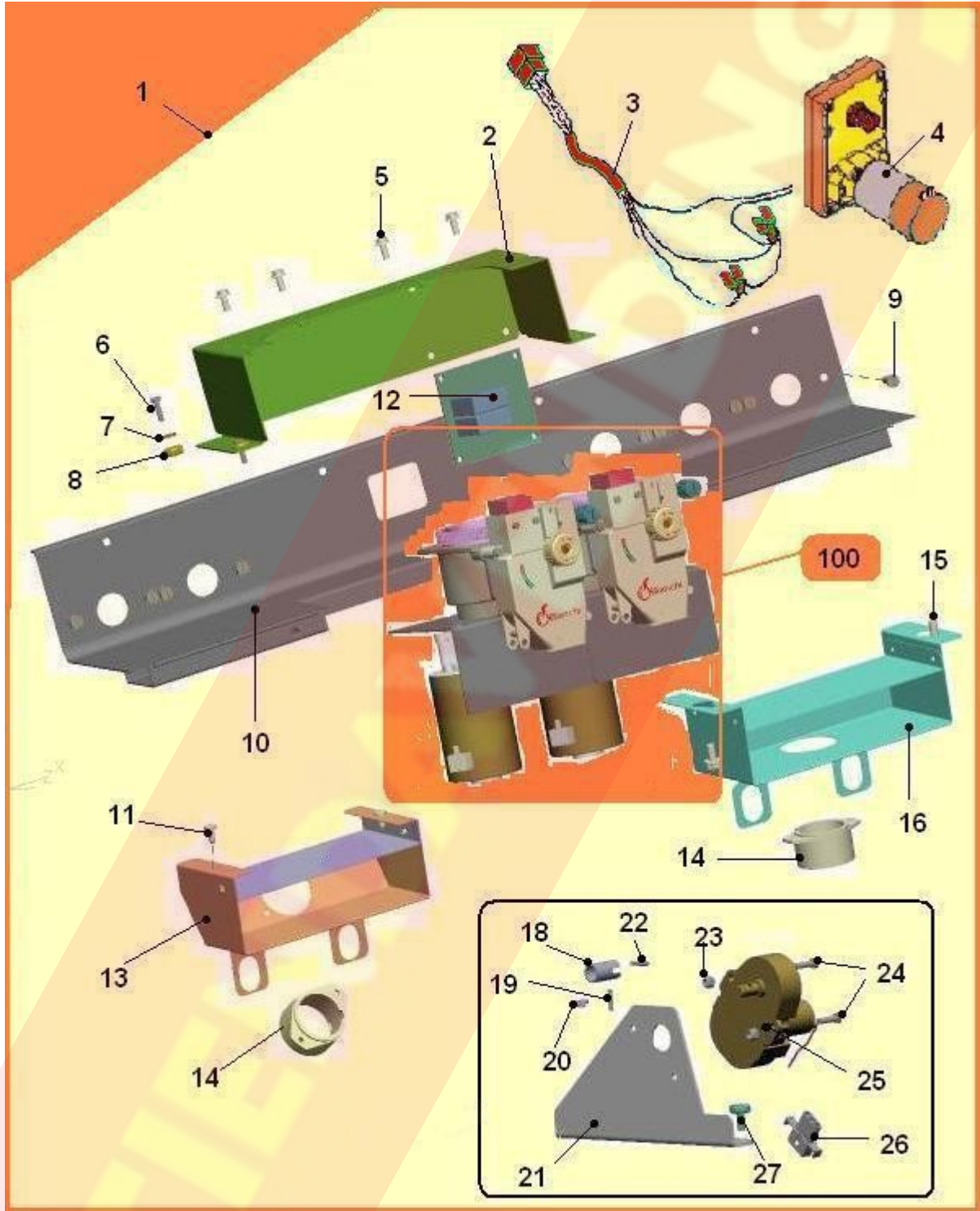

## C/O SUPP. MACINADOSATORE-MOTORI DUTTORI SCATOLE DOSATRICI ( 815) - Detalle de los artículos

| POSICIÓN | CODIGO DE REPUESTO                                 | Accesorios | DESCRIPCIÓN                    | Para cada artículo principal<br>multiplique q.ty cerca |
|----------|--|------------|--------------------------------|--|
| 1        | 96067240   |            | C/O MACINADOS/PROD.DC DM BV972 |  |
| 2        | 01871811   |            | SOSTEGNO MACININI BVM972 DC DM |  |
| 3        | 22178122   |            | CABL.MOTORIDUTTORI BVM972 DM   |  |
| 4        | 20017026   |            | MOTORID. 24VDC 100G/M S/CAB    |  |
| 5        | 32123016   |            | VITE TECR M5X12                |  |
| 6        | 32055516   |            | tornillo TE M4x16              |  |
| 7        | 35160316   |            | arandela dent.d.4,2            |  |
| 8        | 23004086   |            | PASSACAVO DM. 6X15 GOMMA       |  |
| 9        | 32130616   |            | tornillo tc dm.10 6ma x 16     |  |
| 10       | 01829121   |            | PIASTRA SUPP.SCAT/PROD.BV972DM |  |
| 11       | 32222856   |            | tornillo autorroscante 3,9     |  |
| 12       | 26050516   |            | SCHEDA DOPPIO MACININO         |  |
| 13       | 01871712   |            | ASS.SCATOLA SUPP. ASPIRAZ. DM  |  |
| 14       | 05071915   |            | boca x aspir.                  |  |
| 15       | 32122916   |            | tornillo M5x10                 |  |
| 16       | 01829021-01  |            | SUPP.SCAT.ASPIRAZION.BV972 DC  |  |
| 18       | 19068811   |            | BOCCOLA LEVA REGOLAZIONE       |  |
| 19       | 33053046   |            | SPINA ELASTICA 3x14            |  |
| 20       | 19054411   |            | arandela de remache            |  |
| 21       | 01760021   |            | PIASTR.SUPP.MOTORE REGOL.2 MAC |  |
| 22       | 33053146   |            | SPINA ELASTICA 3x16            |  |
| 23       | 34110216   |            | tuerca autobl.4ma zin.         |  |
| 24       | 32060816   |            | VITE TC 4MAX16                 |  |
| 25       | 20018426-01  |            | MOTORID.24VDC 12RPM 2,2nF 100V |  |
| 26       | 23009616   |            | connector                      |  |
| 27       | 19043521   |            | sujetador                      |  |
| 100      | Vea la tabla "C/O MACINA-DOSATORE (817)" - Pág. 32 |            |                                |  |

Tabla: C/O CASSETTO BVM 972 DC (821)

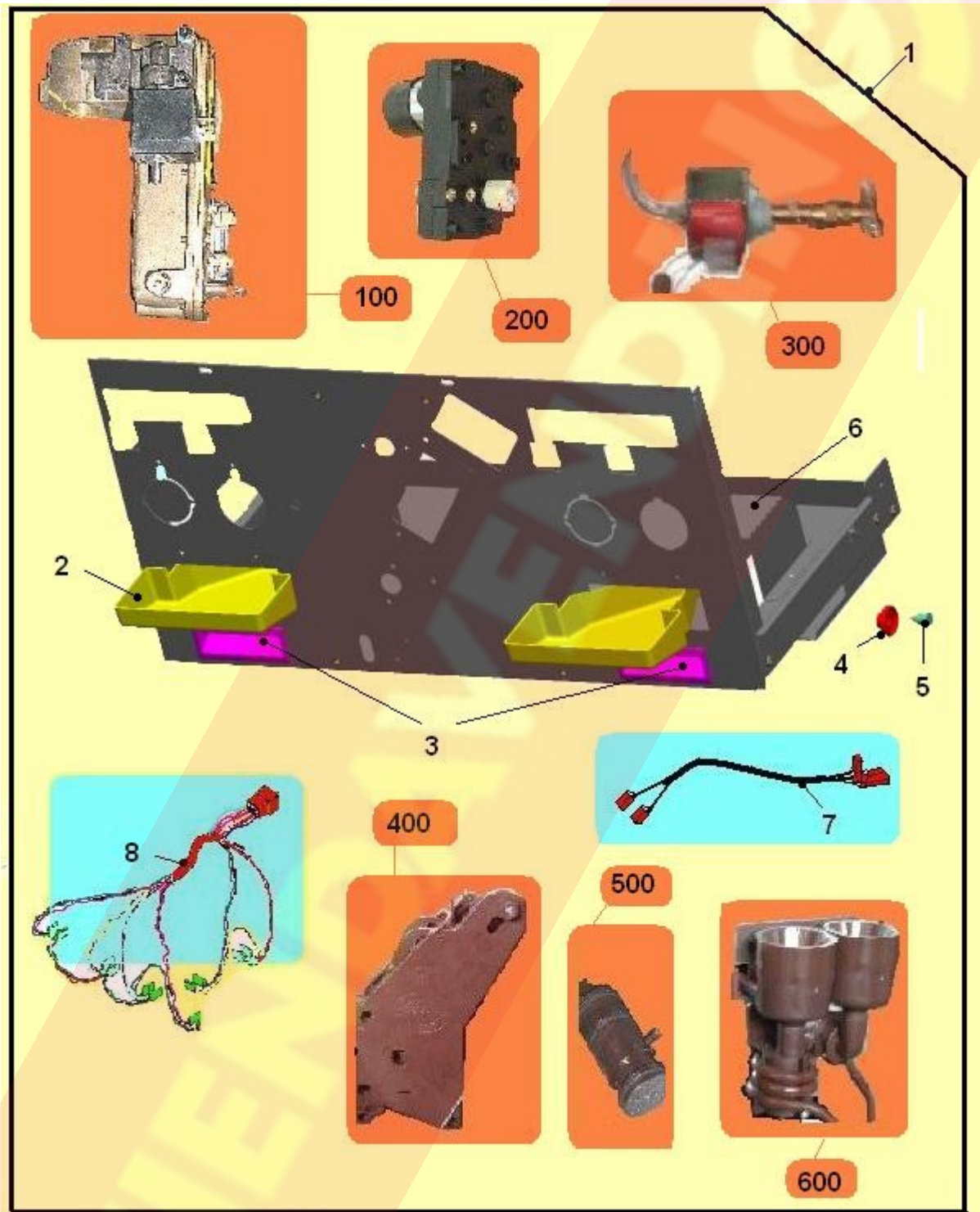

## C/O CASSETTO BVM 972 DC (821) - Detalle de los artículos

| POSICIÓN | CODIGO DE REPUESTO  | Accesorios | DESCRIPCIÓN                    | Para cada artículo principal<br>multiplique q.ty cerca |
|----------|---|------------|--------------------------------|--|
| 1        | 96067360-01   |            | C/O CASSETTO BVM 972 DC DM     |  |
| 2        | 05117415M37   |            | recipiente sop.batidor 2       |  |
| 3        | 05238516  |            | MANIGL.PLS SOUTHCO BV971 IVS   |  |
| 4        | 05116416  |            | rodamiento de cajon            |  |
| 5        | 12016116  |            | perno de rueda cajon           |  |
| 6        | 01831432-01   |            | ASS.LAM. CASSETTO BVM972 DC DM |  |
| 7        | 22178412  |            | CABL.SONDA BV971 IVS           |  |
| 8        | 22177912-02   |            | CABL.GR/CASSETTO BV97 C/GUAINA |  |
| 100      | Vea la tabla "CALDERA(8)" - Pág. 20                               |            |                                |  |
| 200      | Vea la tabla "MOTORIDUTTORE GRUPPO CAFFE' (483)" - Pág. 24        |            |                                |  |
| 300      | Vea la tabla "POMPA ACQUA - RILEVATORE DI FLUSSO (830)" - Pág. 75 |            |                                |  |
| 400      | Vea la tabla "GRUPO CAFE' PLASTICO(1)" - Pág. 22                  |            |                                |  |
| 500      | Vea la tabla "ASSIEME PISTONE (822)" - Pág. 28                    |            |                                |  |
| 600      | Vea la tabla "COMPONENTI PER MISCELATORI (823)" - Pág. 73         |            |                                |  |



Tablas del grupo :

- 🔗 Maquinas de Cafe
  - 📁 BVM 972 - Free Standing
    - 📁 BV972ES08GG - BVM972 E5S DC DM PD
      - 📁 C/O SOLUBILI

TIENDA VENDING

Tabla: SCATOLE DOSATRICI POLVERI (654)

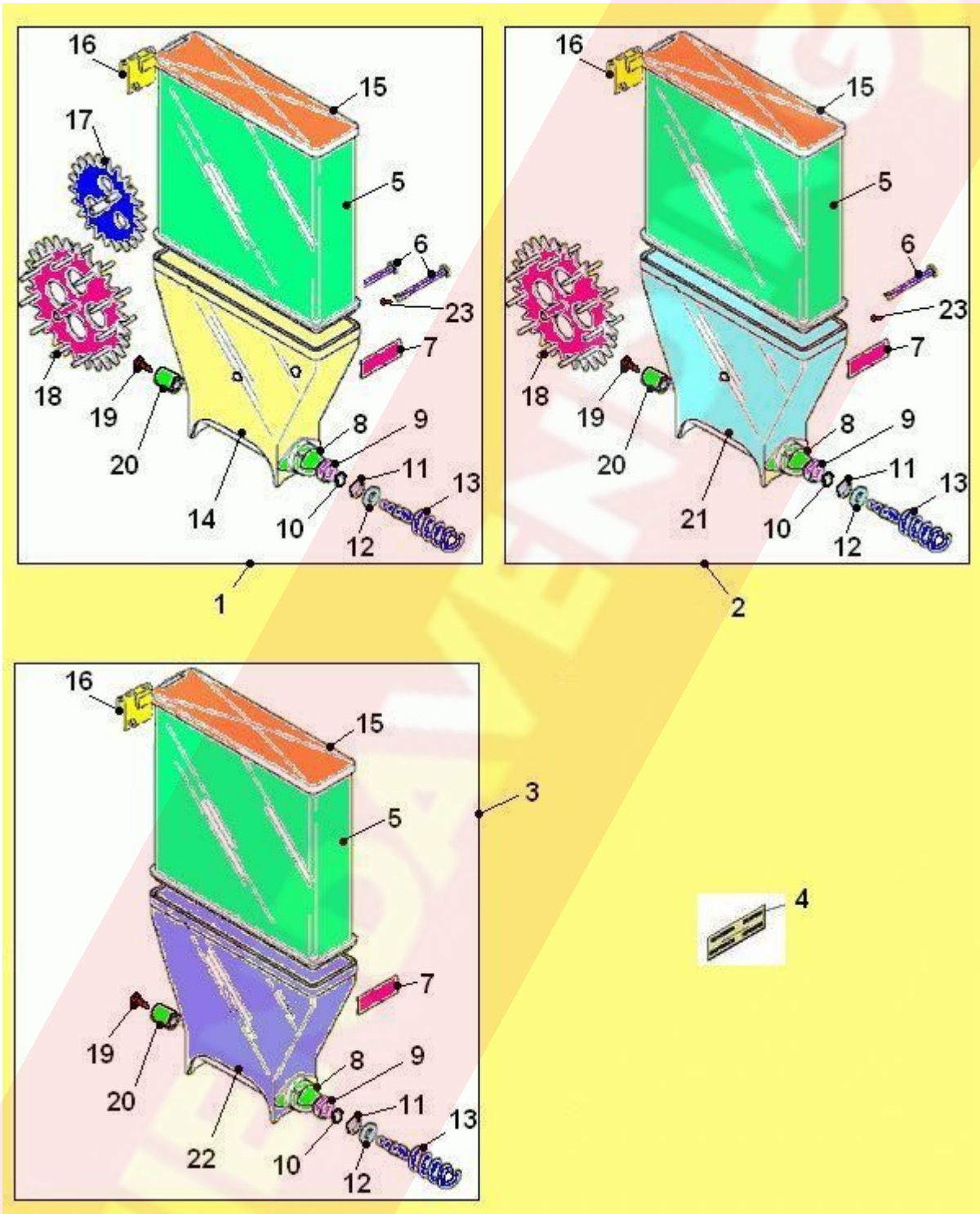

## SCATOLE DOSATRICI POLVERI (654) - Detalle de los artículos

| POSICIÓN | CODIGO DE REPUESTO | Accesorios | DESCRIPCIÓN                    | Para cada artículo principal<br>multiplique q.ty cerca |
|----------|--------------------|------------|--------------------------------|--|
| 1        | 96035620-01        |            | tolva 2 ruedas alta            |  |
| 2        | 96034330-01        |            | tolva 1 rueda alta             |  |
| 3        | 96034420-01        |            | C/O SCAT.DOS. S/R ALTA         |  |
| 4        | 30064911-01        |            | SERIE TARGHET.PVC X SCAT. DOSA |  |
| 5        | 05112715           |            | tolva dosificadora superio     |  |
| 6        | 05133115-01        |            | eje para rueda                 |  |
| 7        | 05113415           |            | gancho cierre tolva            |  |
| 8        | 05158515-01        |            | boca erog.caja dos.            |  |
| 9        | 05112535           |            | BOCCOLA PERNO COCLEA X GUARN.  |  |
| 10       | 36200616           |            | GUAR.O-RING 15X2               |  |
| 11       | 36250016           |            | guarnic. de 043                |  |
| 12       | 05113215           |            | hebilla de sosten para sin     |  |
| 13       | 05124515           |            | sinfin de extraccion           |  |
| 14       | 05158615-02        |            | SCAT.DOS-INF X 2 RUOTE         |  |
| 15       | 05112915           |            | cobertura tolva                |  |
| 16       | 05113015           |            | gancho apoyo tolva             |  |
| 17       | 05112315           |            | rueda dent. secundaria         |  |
| 18       | 05112215-01        |            | rueda dent. principal          |  |
| 19       | 32222916           |            | tornillo autorroscante 2,9     |  |
| 20       | 05113315           |            | acoplador para sinfin          |  |
| 21       | 05158625-02        |            | SCAT.DOS.-INF. X 1 RUOTA       |  |
| 22       | 05158635-02        |            | SCAT.DOS-INF.X S/RUOTA         |  |
| 23       | 05160215           |            | TASSELLO PER PERNO SCATOLE     |  |

Tabla: C/O CALDAIA SOLUBILI 5 ELETTROV. (820)

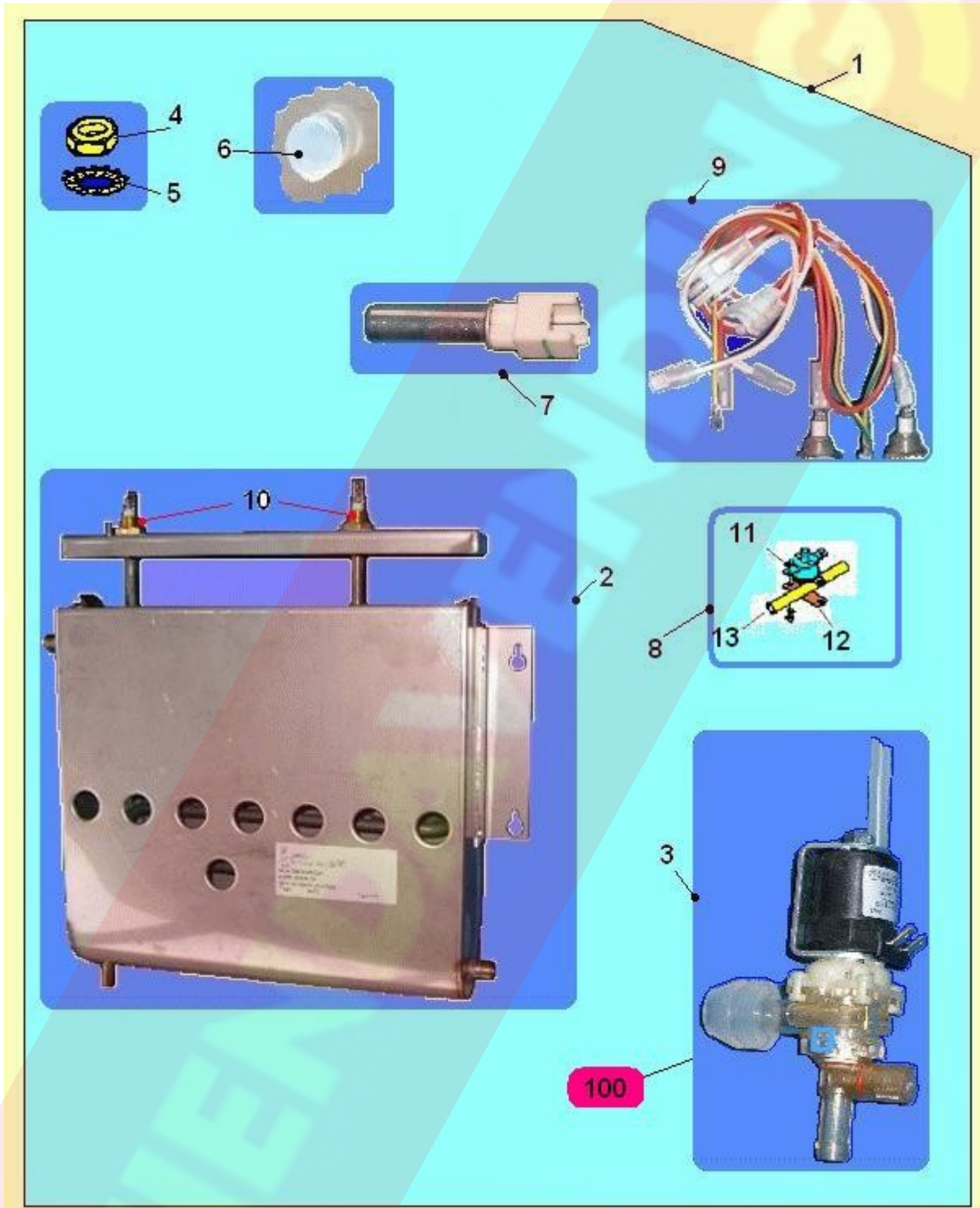

## C/O CALDAIA SOLUBILI 5 ELETTROV. (820) - Detalle de los artículos

| POSICIÓN | CODIGO DE REPUESTO  | Accesorios | DESCRIPCIÓN                    | Para cada artículo principal<br>multiplique q.ty cerca |
|----------|---|------------|--------------------------------|--|
| 1        | 87011540  |            | C/O CALD.5 EL-VALV.BV972 DC DM |  |
| 2        | 01846210  |            | ASS.CALDAIA 7 ELETTROVAL.BV972 |  |
| 3        | 25032616  |            | E.V.CADUT.CALD.SOL BV972+MANIC |  |
| 4        | 34102826  |            | DADO 4MA OTTONE                |  |
| 5        | 35160316  |            | arandela dent.d.4,2            |  |
| 6        | 05248526  |            | MANIC.CHIUS.EL-VAL.CALD.006779 |  |
| 7        | 26051616  |            | SENS.TEMPERAT.C/NTC 100K BV972 |  |
| 8        | 25019620  |            | conj tubo clixon 75°           |  |
| 9        | 22183312-01   |            | CABL.230 CAL.IN 972 DC C/GUAIN |  |
| 11       | 25014936-01   |            | clixon                         |  |
| 12       | 01213411  |            | tabla x clixon                 |  |
| 13       | 09078221  |            | tubito x clixon                |  |
| 100      | Vea la tabla "COMPONENTI ELETTROVALVOLA SOLUBILI (832)" - Pág. 77 |            |                                |  |

Tabla: C/O SCATOLA ORZO/CAFFE BV972 (826)

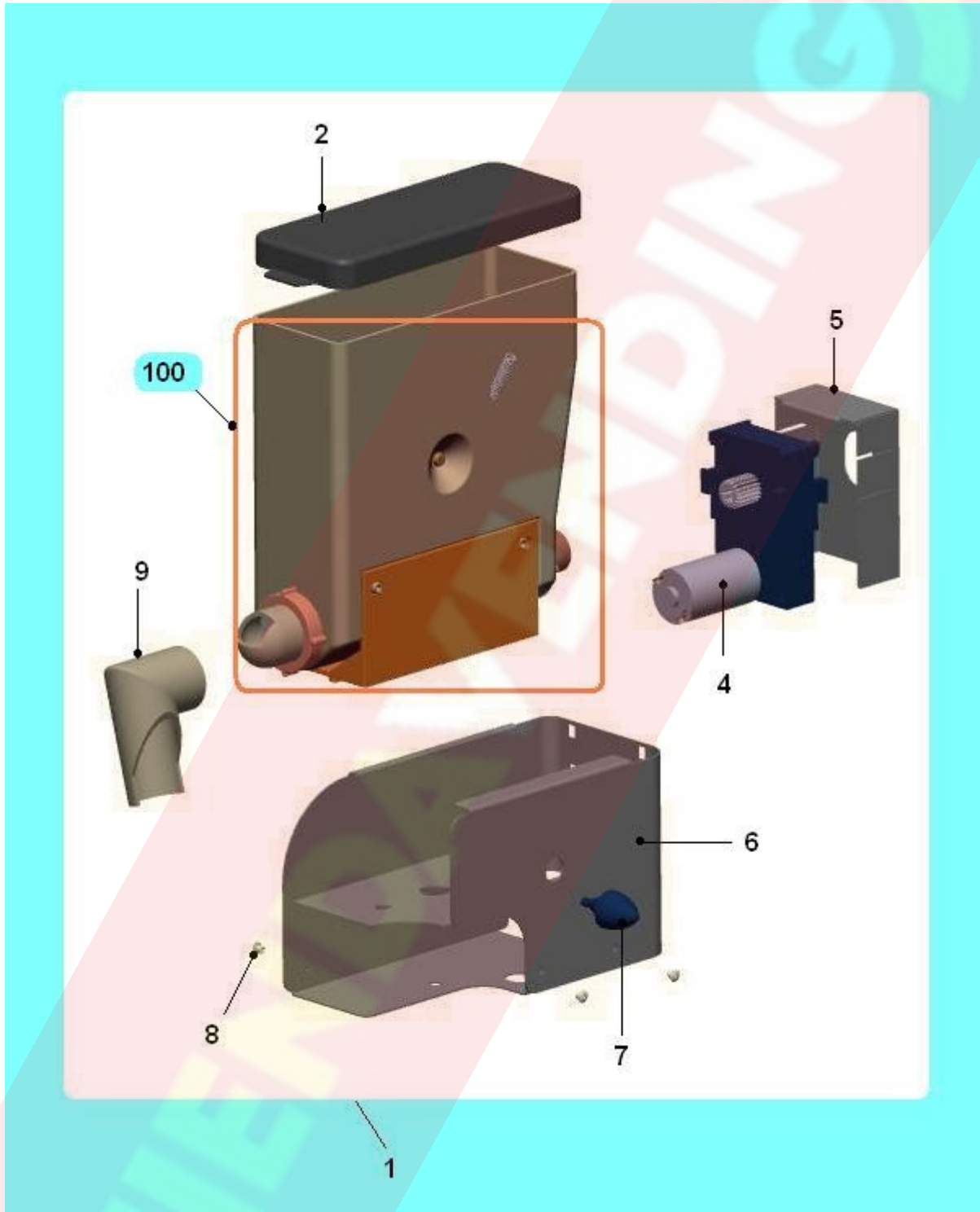

## C/O SCATOLA ORZO/CAFFE BV972 (826) - Detalle de los artículos

| POSICIÓN | CODIGO DE REPUESTO   | Accesorios | DESCRIPCIÓN                    | Para cada artículo principal<br>multiplique q.ty cerca |
|----------|--|------------|--------------------------------|--|
| 1        | 96069110   |            | C/O SCATOLA ORZO/CAFFE BVM972  |  |
| 2        | 05245216   |            | COPERC.SCATOLA DOS.GRAF BVM300 |  |
| 4        | 20020316   |            | motored.amel enganche rápido   |  |
| 5        | 01885811   |            | MASCHERA MOTORIDUTTORE         |  |
| 6        | 01872012-01  |            | ASS.SCATOLA CAFFE LIOFILIZZATO |  |
| 7        | 05192515   |            | GOMM.CONICO X SERRAG.P.COIB. 5 |  |
| 8        | 33050126   |            | remache 3,2x8                  |  |
| 9        | 05230126   |            | PIPA DX 45X65 SCARICATA        |  |
| 100      | Vea la tabla "COMPONENTI SCATOLA ORZO/CAFFE (908)" - Pág. 79 |            |                                |  |

Tabla: PARTI DI COMPLETAMENTO (824)

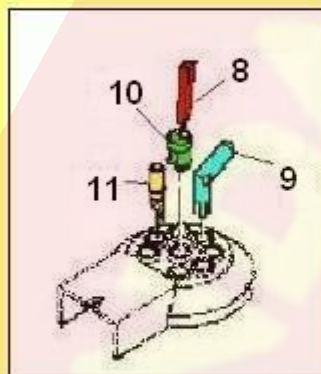
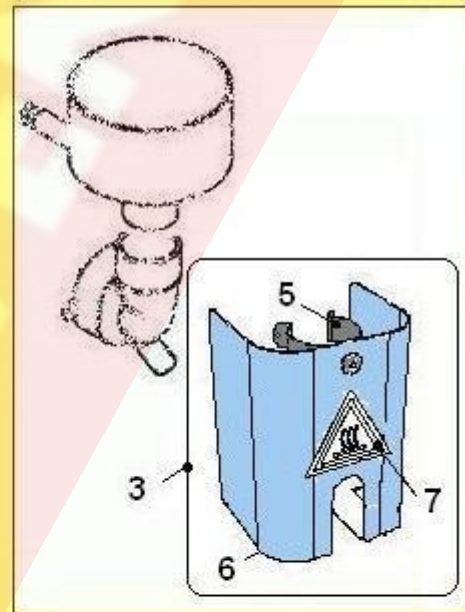
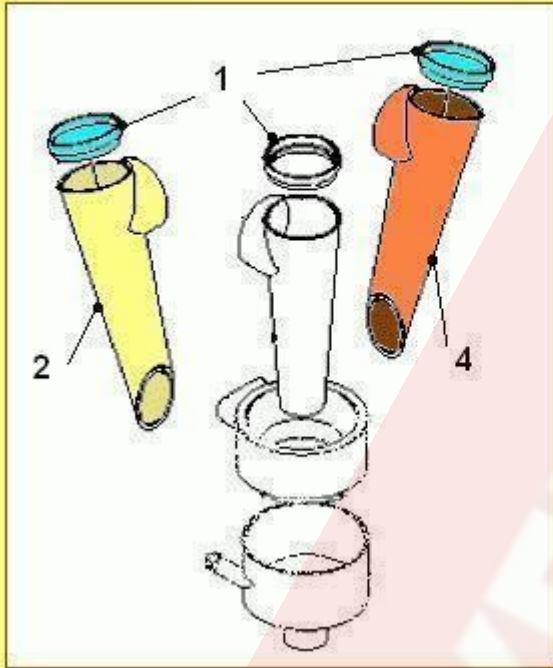



## PARTI DI COMPLETAMENTO (824) - Detalle de los artículos

| POSICIÓN | CODIGO DE REPUESTO | Accesorios | DESCRIPCIÓN                    | Para cada artículo principal<br>multiplique q.ty cerca |
|----------|--------------------|------------|--------------------------------|--|
| 1        | 05160415-01M37     |            | tapa color marron              |  |
| 2        | 05160665           |            | embudo polvo izq. L=101 maron  |  |
| 3        | 01833512           |            | ASS.COPERTURA COPPETTA RISCALD |  |
| 4        | 05160655           |            | embudo polvo der L=101 maron   |  |
| 5        | 23036116           |            | GANCIO C/VITE E DADO EIS 37/C  |  |
| 6        | 01833311-01        |            | COPERTURA COPPETTA RISCALDATA  |  |
| 7        | 30069411-01        |            | TARGH.AVVERT.TEMPERATURA       |  |
| 8        | 05099715-01M57     |            | UGELLO CAPILLARE L=48 AM       |  |
| 9        | 05089815-02M57     |            | BECCUC.EROGAZ.A GOMITO NERO AM |  |
| 10       | 05099615           |            | anillo pico capillare          |  |
| 11       | 05096025M57        |            | BECC.EROGAZ.DIRIT.SMUS.NERO AM |  |

Tablas del grupo :

- 🔗 Maquinas de Cafe
  - 📁 BVM 972 - Free Standing
    - 📁 BV972ES08GG - BVM972 E5S DC DM PD
      - 📁 PARTI ELETTRICHE



Tabla: ASSIEME SCATOLA ELETTRICA (652)



## ASSIEME SCATOLA ELETTRICA (652) - Detalle de los artículos

| POSICIÓN | CODIGO DE REPUESTO | Accesorios | DESCRIPCIÓN                     | Para cada artículo principal<br>multiplique q.ty cerca |
|----------|--------------------|------------|---------------------------------|--|
| 1        | 94033530-01        |            | ASS.SCATOLA ELETT.BVM972 DC     |  |
| 2        | 23017316           |            | portafusible a resorte 6,3      |  |
| 3        | 23014926-01        |            | fusible 12,5A                   |  |
| 4        | 30069511-02        |            | TARGH. FUSIB. ORION GP          |  |
| 5        | 26048516           |            | SCHEDE ESPANSIONE NTC/TRIAC     |  |
| 6        | 23014416           |            | toma 2P+T                       |  |
| 7        | 22177612-01        |            | CABL.INTER. +PRESA BV97C/GUAINA |  |
| 8        | 30077911           |            | tarjeta puesta a tierra         |  |
| 9        | 22043022           |            | CORD.MESSA TERRA L=200 OCCH.4   |  |
| 10       | 26026326           |            | FILTR.RETE ATT-SCATT.C/CAVO A   |  |
| 11       | 23038816           |            | MORSETTIERA PER BVM             |  |
| 12       | 26048316           |            | aliment.switch 230/110Vac-24Vd  |  |
| 13       | 22177512-01        |            | CABL.ALIM. SWITCH.BV97 C/GUAIN  |  |
| 14       | 01828821-03        |            | SCATOLA CENTRALINA ELETTR. BVM  |  |
| 15       | 26048416           |            | tarjeta potencia SMT            |  |
| 16       | 22175412           |            | FLAT CABLE 16 VIE L=100mm       |  |
| 17       | 26048616           |            | SCHEDE MACINATURA AUTOMATICA    |  |
| 18       | 22177412-03        |            | CABL.GENERALE BV97 C/GUAINA     |  |
| 19       | 22177712-01        |            | CABL. ASPIRATORE BV97 C/GUAINA  |  |
| 20       | 22175312           |            | CABL.REGOL.MACINATURA BVM971    |  |
| 21       | 22172412-01        |            | CABL.230 SCH-ESPAN.BV C/GUAINA  |  |
| 22       | 22175412           |            | FLAT CABLE 16 VIE L=100mm       |  |

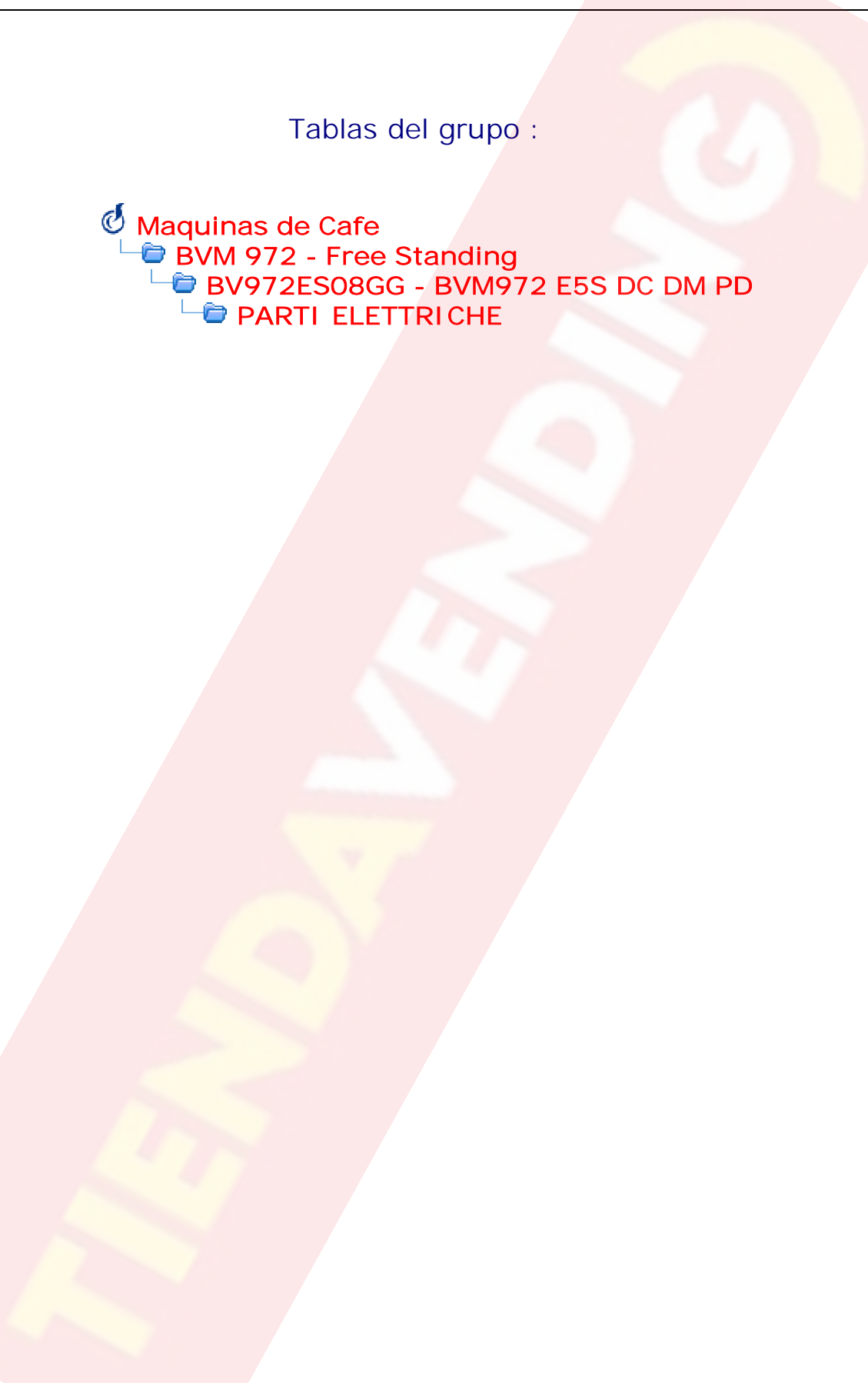
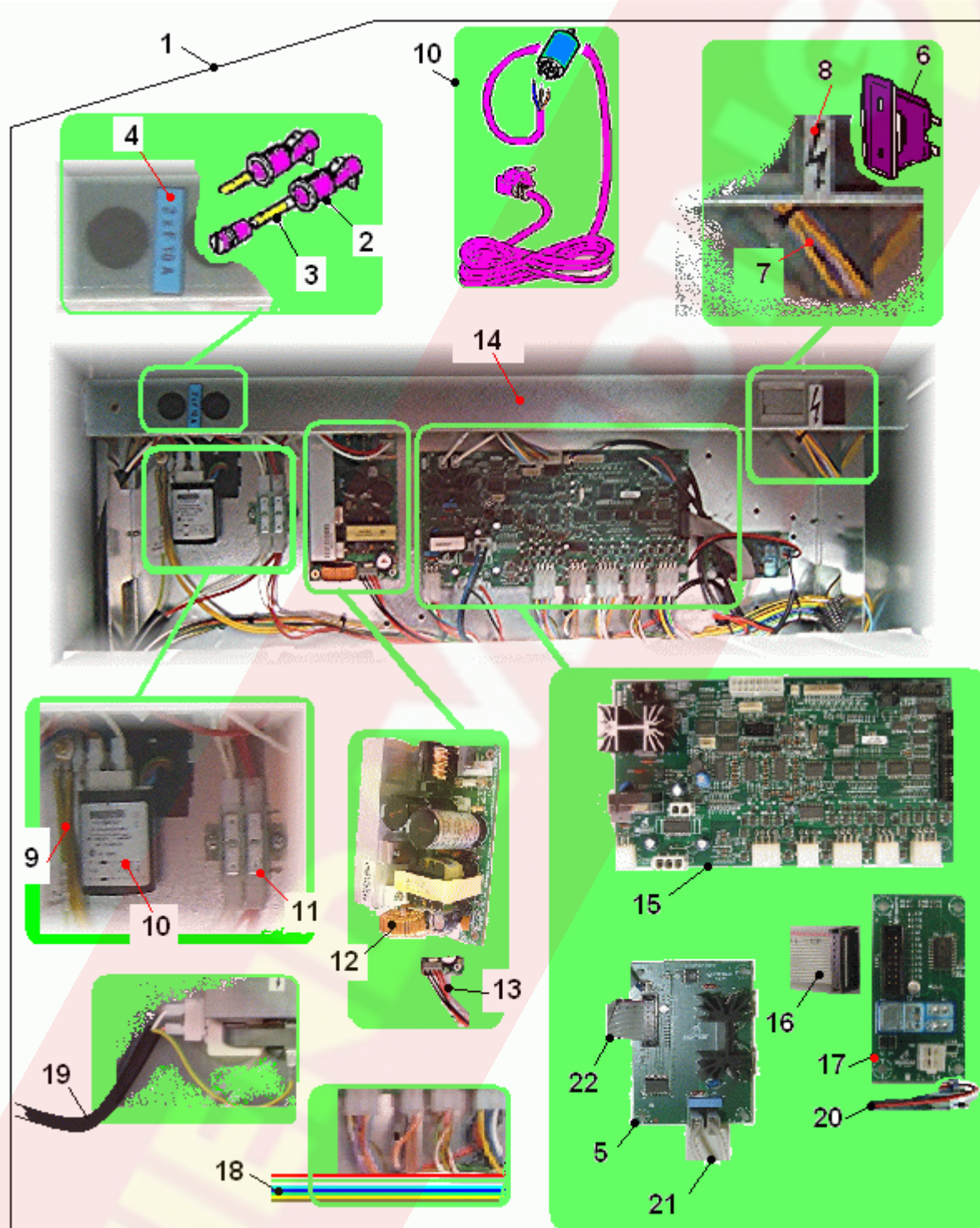
Tabla: SCHEDA ELETTRONICA - MASTER (800)

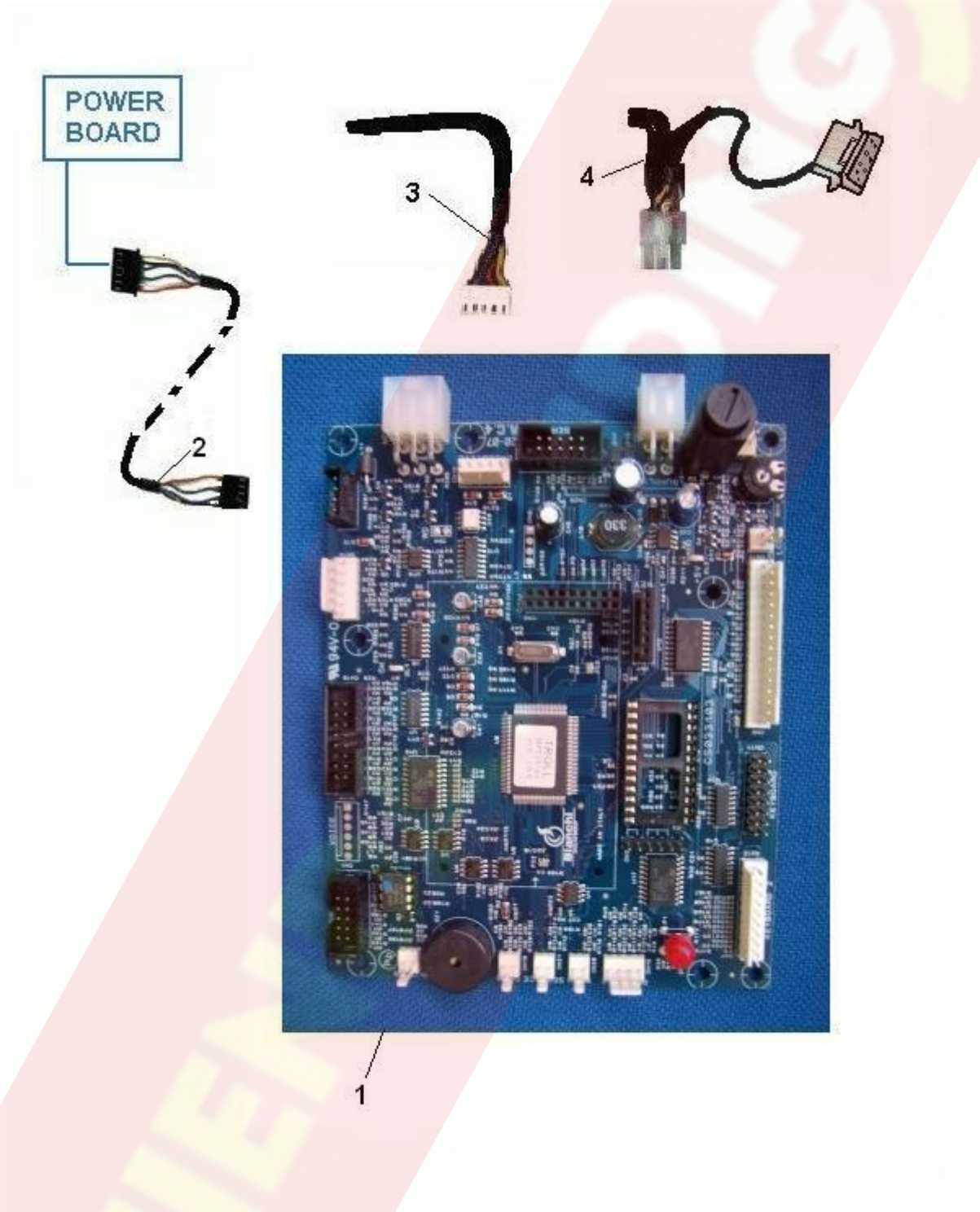

## SCHEDA ELETTRONICA - MASTER (800) - Detalle de los artículos

| POSICIÓN | CODIGO DE REPUESTO Accesorios | DESCRIPCIÓN                    | Para cada artículo principal<br>multiplique q.ty cerca |
|----------|-------------------------------|--------------------------------|--|
| 1        | 26027336-02                   | SCH-CPU BLU SMT C/MICRO 256K   |  |
| 2        | 43020012                      | CABLAG.DA SCH MASTER A POT.SMT |  |
| 3        | 22084222-01                   | cable interfase ejecutivo      |  |
| 4        | 22172312                      | CABL.MDB+ALIM.EXECUT.SIRIO BV  |  |

TIENDA VENDING

Tabla: NEON E PARTI ELETTRICHE (828)

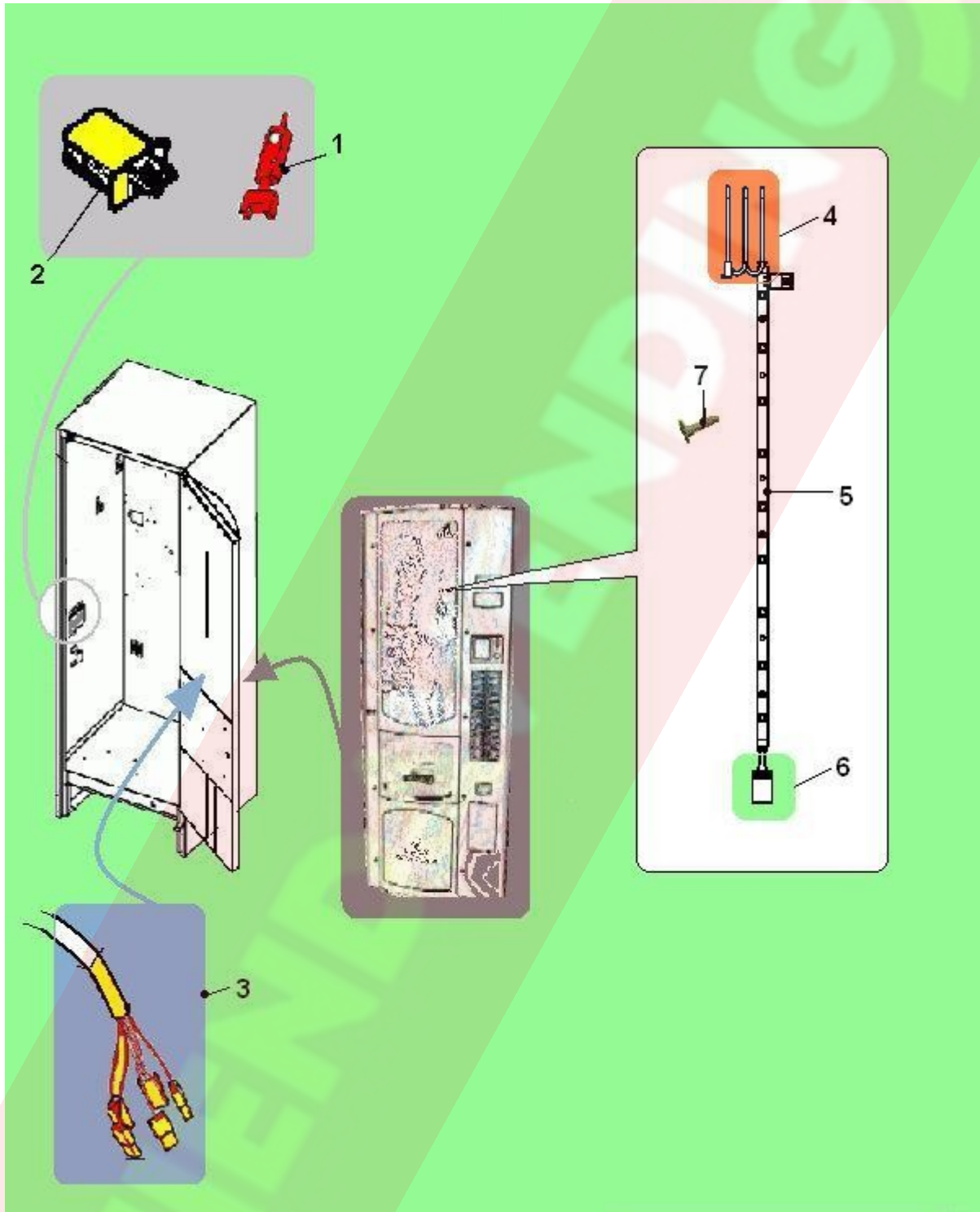

## NEON E PARTI ELETTRICHE (828) - Detalle de los artículos

| POSICIÓN | CODIGO DE REPUESTO Accesorios | DESCRIPCIÓN                    | Para cada artículo principal<br>multiplique q.ty cerca |
|----------|-------------------------------|--------------------------------|--|
| 1        | 05097215-02M09                | CHIAVE DI SERVIZIO XT-CLIX NER |  |
| 2        | 26016726                      | interr.de segurid. XTD22AZ     |  |
| 3        | 22177812-01                   | CABL. PORTA BV970 IVS          |  |
| 4        | 22190616-01                   | CAVO ALIMENT.BARRA LED C/DIODO |  |
| 5        | 26055316                      | BARRA 9 LED 390MM 24VDC        |  |
| 6        | 26055916                      | CONDENSATORE 220UF             |  |
| 7        | 33066316                      | distanc. plaqueta electron     |  |

TIENDA VENDING



Tablas del grupo :

- 🔗 Maquinas de Cafe
  - 📁 BVM 972 - Free Standing
    - 📁 BV972ES08GG - BVM972 E5S DC DM PD
      - 📁 COMPONENTI IDRAULICI



Tabla: ELETTOVALVOLA E VASCHETTA INGRESSO ACQUA (831)



## ELETTROVALVOLA E VASCHETTA INGRESSO ACQUA (831) - Detalle de los artículos

| POSICIÓN | CODIGO DE REPUESTO  | Accesorios | DESCRIPCIÓN                    | Para cada artículo principal multiplique q.ty cerca |
|----------|---|------------|--------------------------------|---|
| 1        | 19046526  |            | anillo de refuerzo. art.24     |   |
| 2        | 04035626  |            | tuerca para codo orient        |   |
| 3        | 04033236  |            | codo orient.                   |   |
| 4        | 19004326  |            | anillo de refuerzo.art.247     |   |
| 5        | 09085423  |            | tubo teflon d4x6               |   |
| 6        | 41023716  |            | soporte válvula flotante       |   |
| 7        | 41024016  |            | cobertura                      |   |
| 8        | 41024316  |            | microint. bt pres.agua v.k     |   |
| 9        | 41024516  |            | piatrina aislante plastico     |   |
| 10       | 41023616  |            | palanquita inox                |   |
| 11       | 16017916  |            | valvula flotante completa      |   |
| 12       | 41023926  |            | SERBATOIO ACQUA                |   |
| 13       | 09040021  |            | tubo silicona 8x12 transpar.   |   |
| 14       | 09027623  |            | tb PVC crist.sz.12x16          |   |
| 15       | 16014316  |            | filtro agua fi-952             |   |
| 16       | 09087823M57   |            | TUBO SILICONE 5X9 NERO AM      |   |
| 17       | 07010711  |            | freno                          |   |
| 18       | 35160716  |            | ROSETTA                        |   |
| 19       | 04036816  |            | recor                          |   |
| 20       | 05111016  |            | guarnic. plana al silicona     |   |
| 21       | 04014131  |            | tuerca es.1/8 gas.             |   |
| 22       | 04000131  |            | curva 3/4 GF 1/8 gm            |   |
| 23       | 05111026  |            | arandela                       |   |
| 24       | 04036846  |            | codo orient.6-1/4 A-235        |   |
| 25       | 25000146  |            | electroválv.ingr. agua 24VDC   |   |
| 26       | 01525121-01   |            | SQUADR.SUPP.E-VALVOLA BRITA    |   |
| 27       | 09085423  |            | tubo teflon d4x6               |   |
| 28       | 04040716  |            | codo directo 1/8 - 3/8         |   |
| 29       | 04036816  |            | recor                          |   |
| 30       | 25032560  |            | ASS.SUP.E-VALV.BVMxBRITA MC/DC |   |
| 31       | 93008430  |            | C/O VASCH.ACQUA CON 1 MICROxDC |   |
| 100      | Vea la tabla "POMPA ACQUA - RILEVATORE DI FLUSSO (830)" - Pág. 75 |            |                                |   |

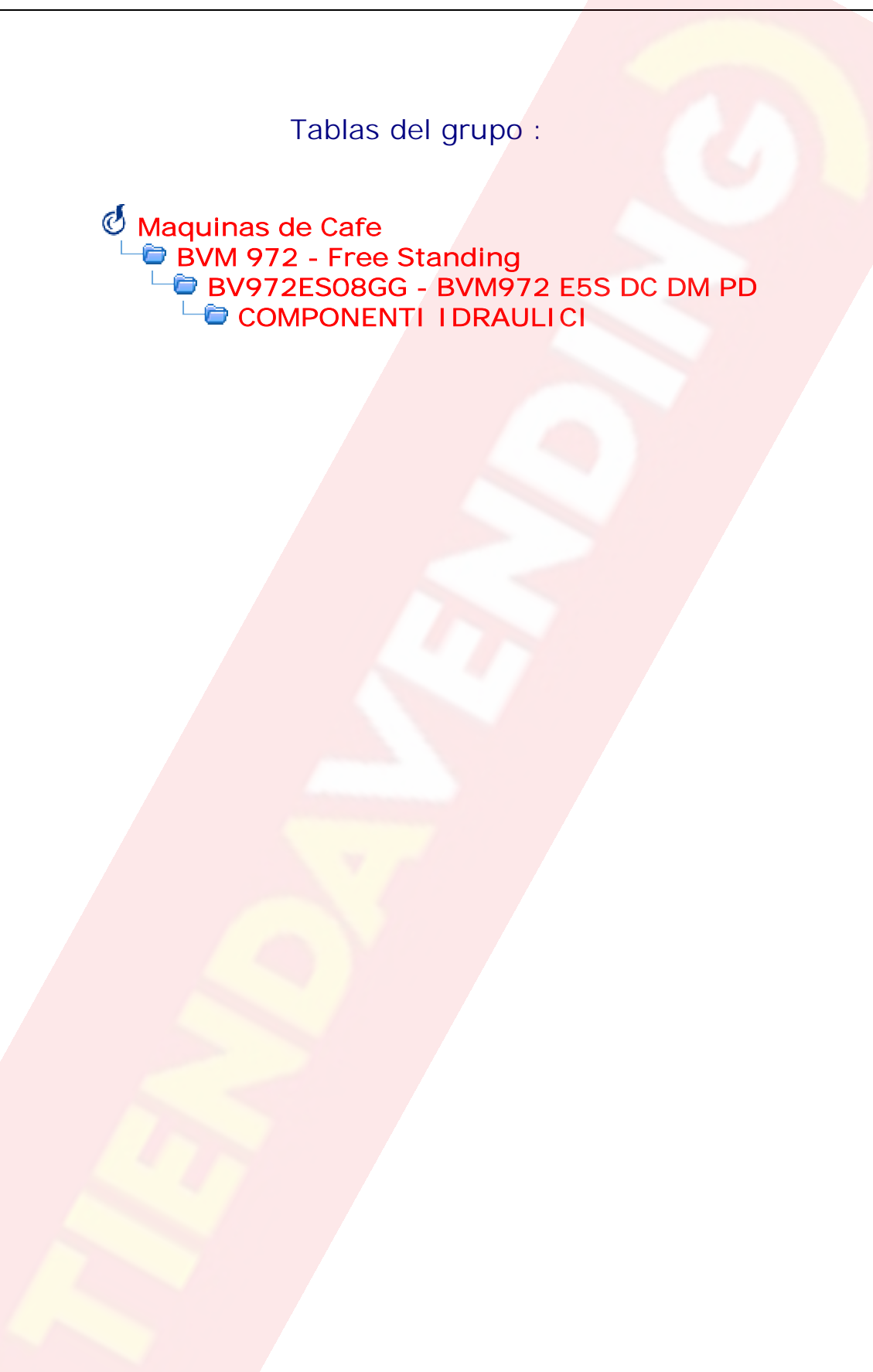
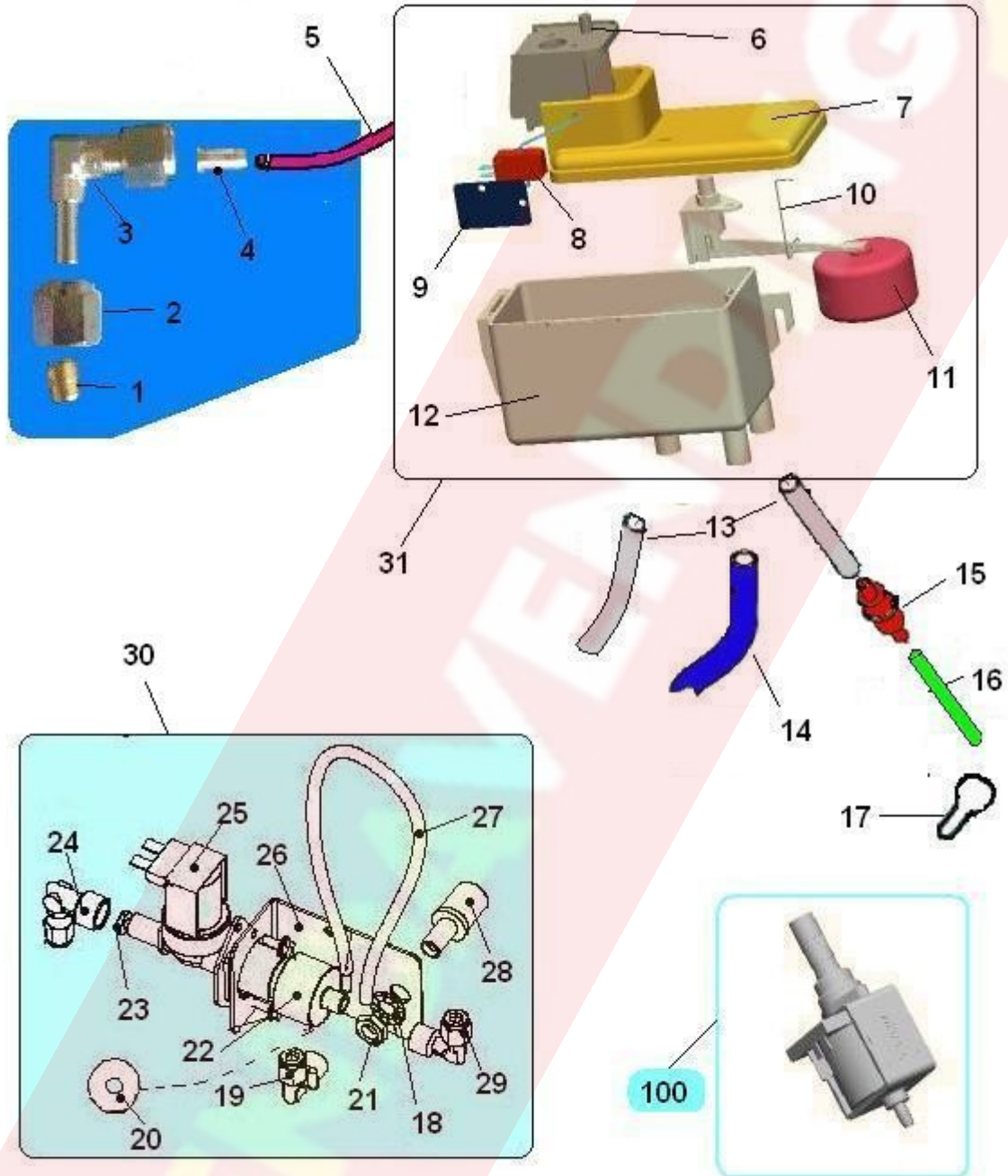
Tablas del grupo :

 **Otras tablas**

TIENDA VENDING

Tabla: COMPONENTI SUPPORTO UGELLI (603)

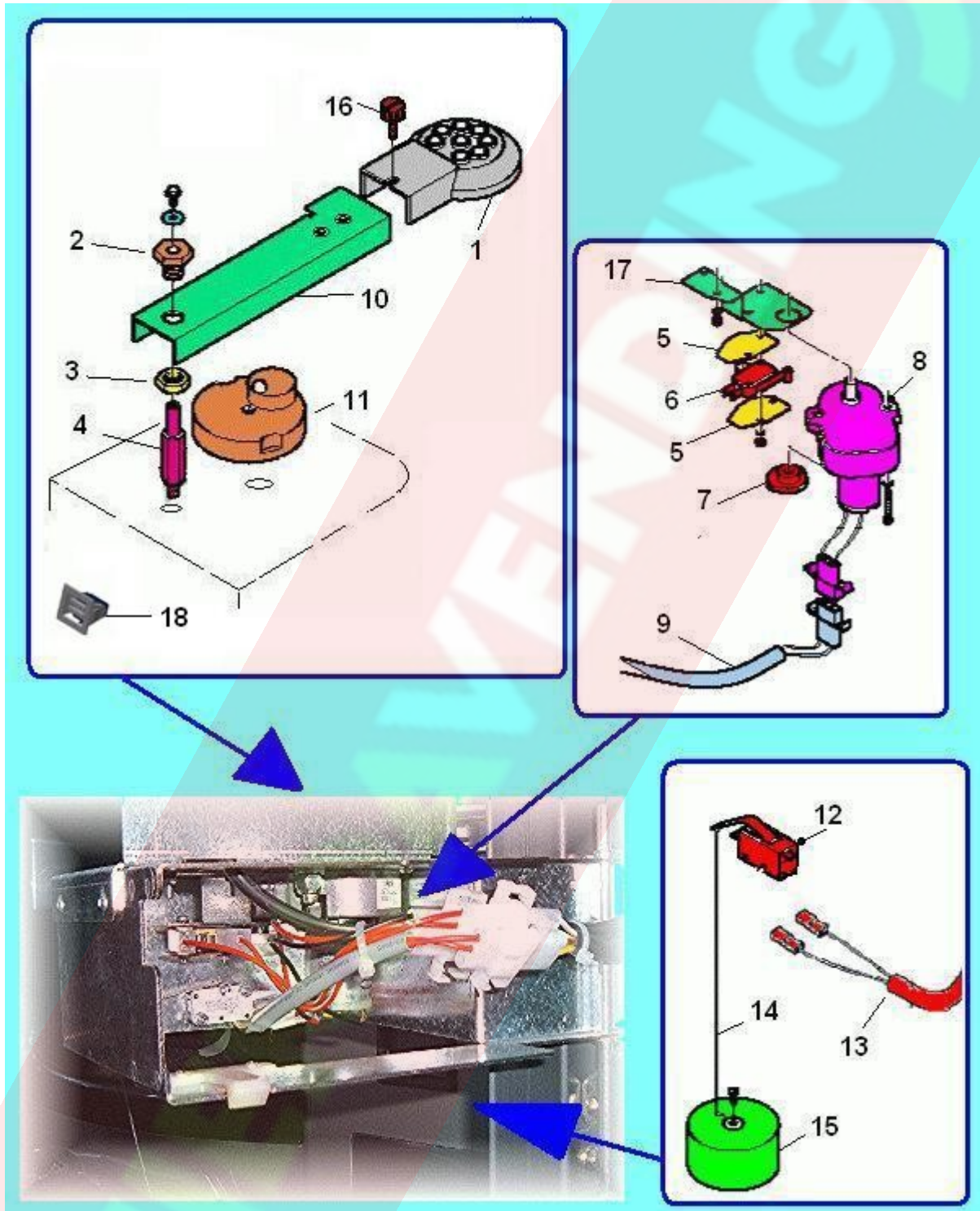

## COMPONENTI SUPPORTO UGELLI (603) - Detalle de los artículos

| POSICIÓN | CODIGO DE REPUESTO Accesorios | DESCRIPCIÓN                    | Para cada artículo principal multiplique q.ty cerca |
|----------|-------------------------------|--------------------------------|---|
| 1        | 05089925-01M37                | pestanda superior 8 POS. PA66  |   |
| 2        | 19057411                      | anillo brazo picos             |   |
| 3        | 04014111                      | DADO ESAG.1/4 GAS              |   |
| 4        | 19057311-04                   | PERNO BRACCIO UGELLI ANTARES   |   |
| 5        | 08004111                      | aislante micro                 |   |
| 6        | 26005126                      | micro con rueda xgm281s20      |   |
| 7        | 05110715                      | cama micro                     |   |
| 8        | 20018816-01                   | motorredu. 24Vbieje 2,2nF 100V |   |
| 9        | 22111312                      | cableado soporte picos bt.     |   |
| 10       | 01509811-01                   | BRACC.SUPP. UGELLI ANTARES     |   |
| 11       | 05089715M37                   | cama traccion. picos           |   |
| 12       | 26013726                      | micro para demasiado lleno     |   |
| 13       | 22130312                      | cordón micro flotante          |   |
| 14       | 22021116                      | hilo de nylon d.0,80           |   |
| 15       | 05074412                      | conj. flotante                 |   |
| 16       | 19043521                      | sujetador                      |   |
| 17       | 01630011-01                   | SQUADR. SUPP. MICRO            |   |
| 18       | 33072816                      | MOLLETTA A SCATTO RICHCO DCS7  |   |

Tabla: COMPONENTI SGANCIA BICCHIERI (628)

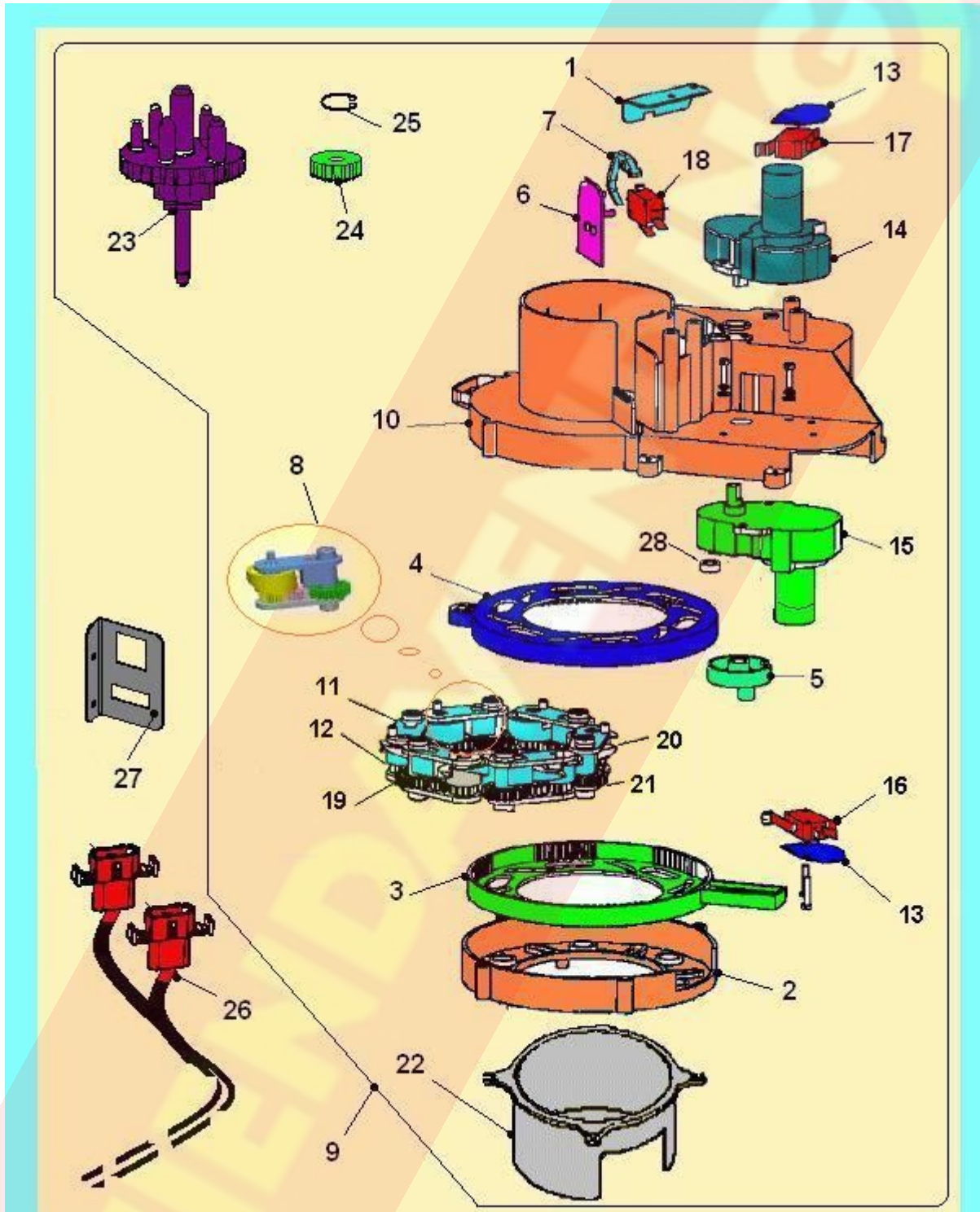

## COMPONENTI SGANCIA BICCHIERI (628) - Detalle de los artículos

| POSICIÓN | CODIGO DE REPUESTO Accesorios | DESCRIPCIÓN                    | Para cada artículo principal multiplique q.ty cerca |
|----------|-------------------------------|--------------------------------|---|
| 1        | 01576411                      | escuadra soporte micro         |   |
| 2        | 05120615M37                   | COPERCH.INF.SG-BIC MARRONE     |   |
| 3        | 05120815M37                   | girante espuls.vasos maròn     |   |
| 4        | 05120915M37                   | GHIERA REGOL.DIAM.SG-BIC MARR. |   |
| 5        | 05121115                      | cama movimentazione girant     |   |
| 6        | 05121215-01M37                | soporte micro maron            |   |
| 7        | 05121315-02                   | sensor presencia vasos         |   |
| 8        | 05131010                      | GRUPPO AZIONAM.SG-BICCH.       |   |
| 9        | 28007110                      | ASS.SG-BICCH.OR-SI-ANT         |   |
| 10       | 05140115M37                   | COPERCH.SUP.C/POP-ALTE MARRON  |   |
| 11       | 05121915                      | SUPP.SUP.CHIOCCIOLA SG-BIC     |   |
| 12       | 05121715                      | PIGNONE FOLLE SG-BIC           |   |
| 13       | 08004111                      | aislante micro                 |   |
| 14       | 20018416-01                   | motored 24VDC 12RPM 2,2nF 100V |   |
| 15       | 20019316-01                   | motorreductor 24V DC (nuevo)   |   |
| 16       | 26005136                      | micro con rueda xgm2-81-s2     |   |
| 17       | 26005156                      | micro c/leva                   |   |
| 18       | 26017016                      | micro s/leva 10 gr.-bt- d4     |   |
| 19       | 05121515                      | CHIOCCIOLA X SG-BIC            |   |
| 20       | 05121615                      | PIGNONE MOV.CHIOCCIOLA SG-BIC  |   |
| 21       | 05121815                      | SUPP.INF.CHIOCCIOLA SG-BIC     |   |
| 22       | 05121015                      | embudo                         |   |
| 23       | 05136015                      | cam de rotación                |   |
| 24       | 05136115                      | piñon motor desengachavastos   |   |
| 25       | 37003116                      | anillo                         |   |
| 26       | 22178612                      | CABL. SGANCIABICCH. BV970 IVS  |   |
| 27       | 01826811                      | PIASTRA CONNETTORE SGANCIATORE |   |
| 28       | 05136215                      | BUSSOLA                        |   |



Tabla: SERRATURA (631)

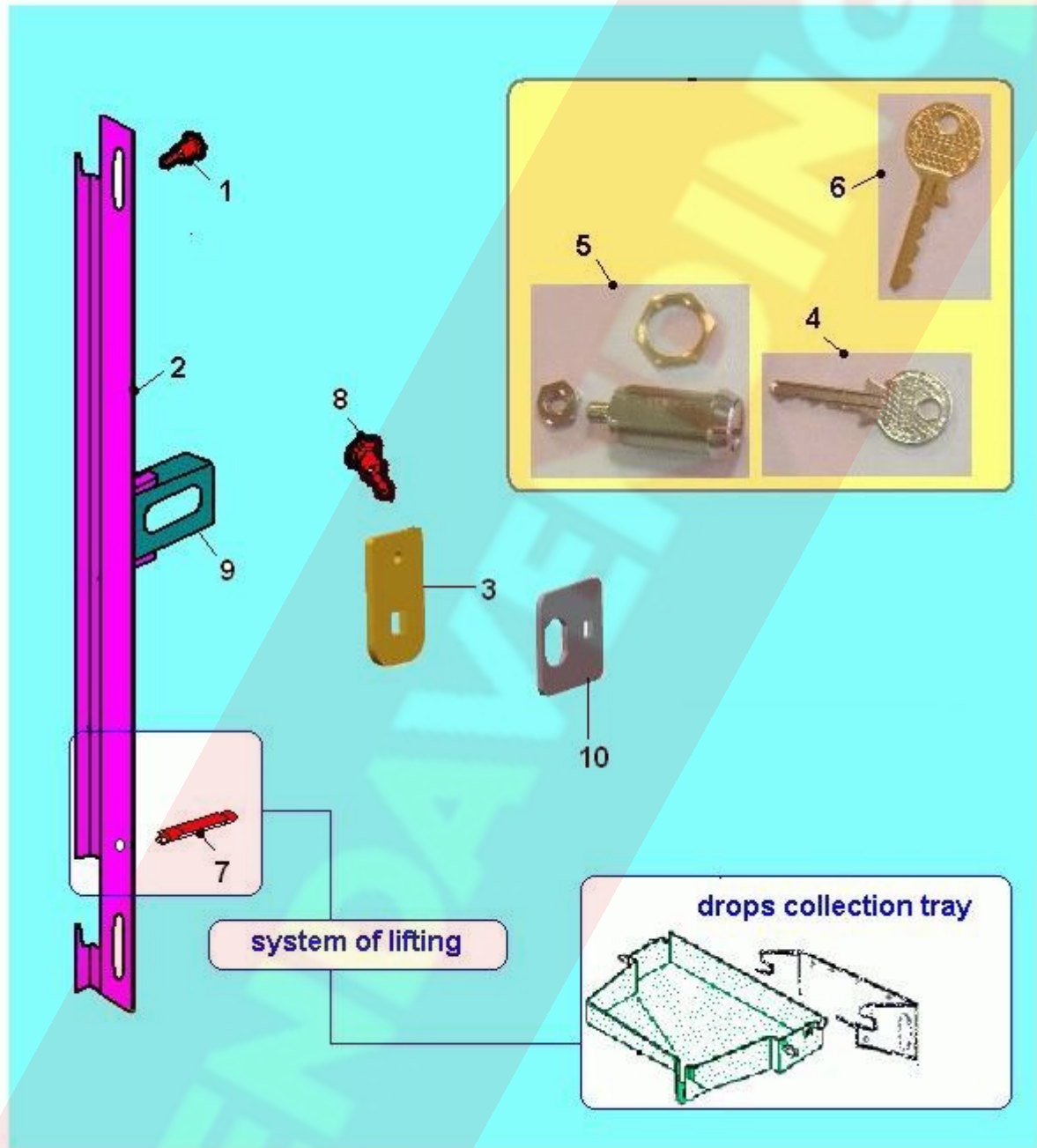

## SERRATURA (631) - Detalle de los artículos

| POSICIÓN | CODIGO DE REPUESTO Accesorios | DESCRIPCIÓN                    | Para cada artículo principal multiplique q.ty cerca |
|----------|-------------------------------|--------------------------------|---|
| 1        | 1905511                       | tornillo x soporte cerrado     |   |
| 2        | 01826111                      | ASTA CHIUSURA PORTA BV971 IVS  |   |
| 3        | 01768221                      | GANCIO SERRATURA RIELDA BVM971 |   |
| 4        | 41029836                      | llave serr. RIELDA para EM     |   |
| 5        | 41029616                      | cerradura Rielda               |   |
| 6        | 43001726                      | llave desbloqueo RELDA EMKA    |   |
| 7        | 05107735M37                   | POMOL.VASCH. RACCOGLIG MARRON  |   |
| 8        | 12016116                      | perno de rueda cajon           |   |
| 9        | 01826211-01                   | PIASTRINA MOVIMENTO ASTA BV971 |   |
| 10       | 01904811                      | RINFORZO SERRATURA BV952/972   |   |



Tabla: VANO EROGAZIONE (633)

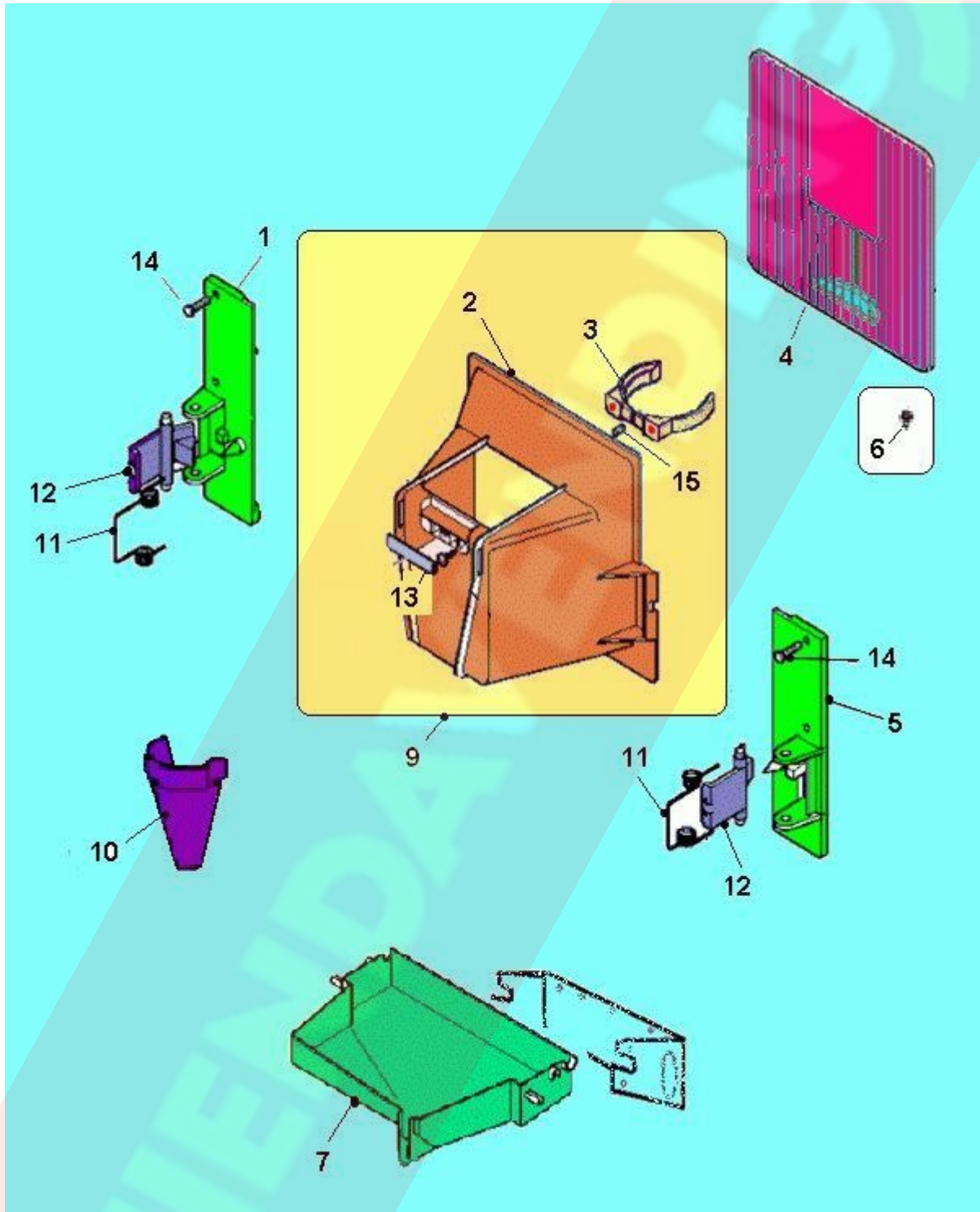

## VANO EROGAZIONE (633) - Detalle de los artículos

| POSICIÓN | CODIGO DE REPUESTO | Accesorios | DESCRIPCIÓN                | Para cada artículo principal multiplique q.ty cerca |
|----------|--------------------|------------|----------------------------|---|
| 1        | 05103425           |            | soporte vano erogacion sx  |   |
| 2        | 05103225           |            | VANO EROGAZ. ORION NERO    |   |
| 3        | 05000315M09        |            | sosten x vasos negro       |   |
| 4        | 05103615           |            | puerta vano erogacion      |   |
| 5        | 05103325           |            | soporte vano erogacion dx  |   |
| 6        | 05099116           |            | goma para antigoteo        |   |
| 7        | 05103715-01M37     |            | caja marron recoj.agua     |   |
| 9        | 05108320           |            | conj. vano erogacion negro |   |
| 10       | 05103815-01        |            | embudo vano erogación      |   |
| 11       | 07017311           |            | resorte leva freno vano er |   |
| 12       | 05103525           |            | leva bloqueo vano erogacio |   |
| 13       | 05134415           |            | PIAST.VANO EROG.           |   |
| 14       | 32090636           |            | tornillo te 5ma x 18 ix.   |   |
| 15       | 32110416           |            | tuerca exagonal. inc.5max1 |   |

Tabla: INTRODUZIONE MONETA (647)

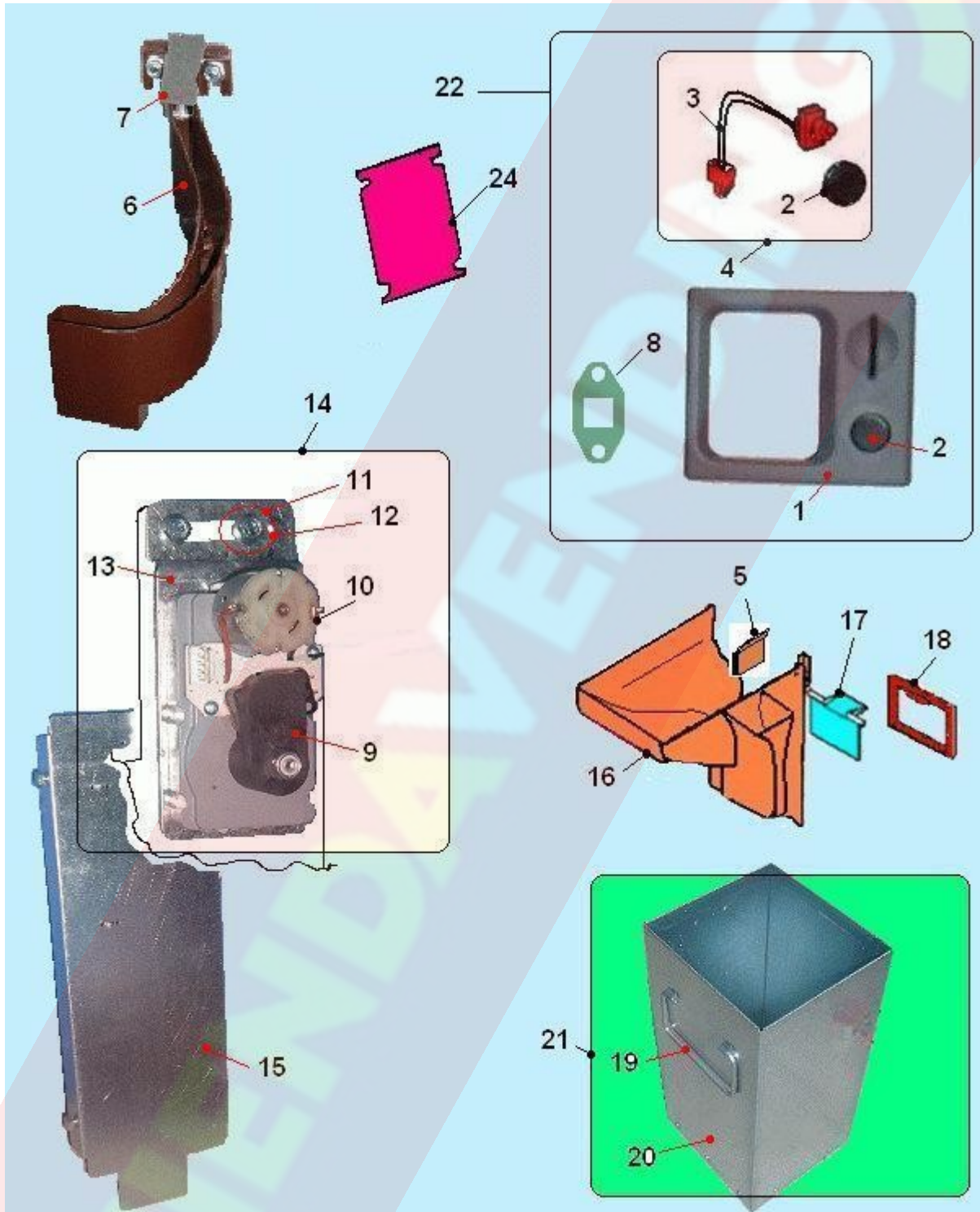

## INTRODUZIONE MONETA (647) - Detalle de los artículos

| POSICIÓN | CODIGO DE REPUESTO Accesorios | DESCRIPCIÓN                    | Para cada artículo principal multiplique q.ty cerca |
|----------|-------------------------------|--------------------------------|---|
| 1        | 05232215M30                   | MASCHE.INTROD.MONETE+M/S GRAF  |   |
| 2        | 05232315M09                   | PULSANTE RENDIRESTO NERO       |   |
| 3        | 26019492                      | ASS.PULSANTE RENDIMONETE       |   |
| 4        | 43018810                      | ASS.PULSANTE RENDIMON C/CAP    |   |
| 5        | 05118241                      | proteccion salvatubo           |   |
| 6        | 05233515M37                   | SCIVOLO INTROD. MONETE MARRON  |   |
| 7        | 01807111                      | TETTO SCIVOL.MONETE IN PLASTI  |   |
| 8        | 01796011                      | PIASTRINA SUPPORTO PULSANTE    |   |
| 9        | 05192815-01M78                | CAMMAXATTUATORE RENDIMON.GRIG  |   |
| 10       | 20031216                      | MOTORIDUTTORE PER RENDIRESTO   |   |
| 11       | 32122916                      | tornillo M5x10                 |   |
| 12       | 34115416                      | tuerca con arandela m5         |   |
| 13       | 01799011-01                   | SUPP.MOTORINO RENDIRESTO       |   |
| 14       | 96065520                      | ASS.MOTOR.RENDIM.BVM951/971    |   |
| 15       | 01825812-01                   | ASS. SUPP. GETTONIERA BVM972   |   |
| 16       | 05233615-01M37                | CANALE RECUPERO MONETE MARRON  |   |
| 17       | 05083115-01M30                | PORTEL. RECUP. MON. GRIGIO     |   |
| 18       | 05246715M30                   | mascara recup.moneda           |   |
| 19       | 12028011                      | MANIGLIA PER CASSETTA MONETE   |   |
| 20       | 01830112-02                   | ASS.CASSETTA MONETE BV971 IVS  |   |
| 21       | 01884220                      | ASS.CASSETTA MONETE C/MANIGLIA |   |
| 22       | 05249010                      | ASS.MASCHERINA MON.C/PULS BVM  |   |
| 24       | 01806311                      | PIASTRINA RINF.FERITOIA M/S    |   |

Tabla: PULSANTIERA - VISUALIZZATORE (825)

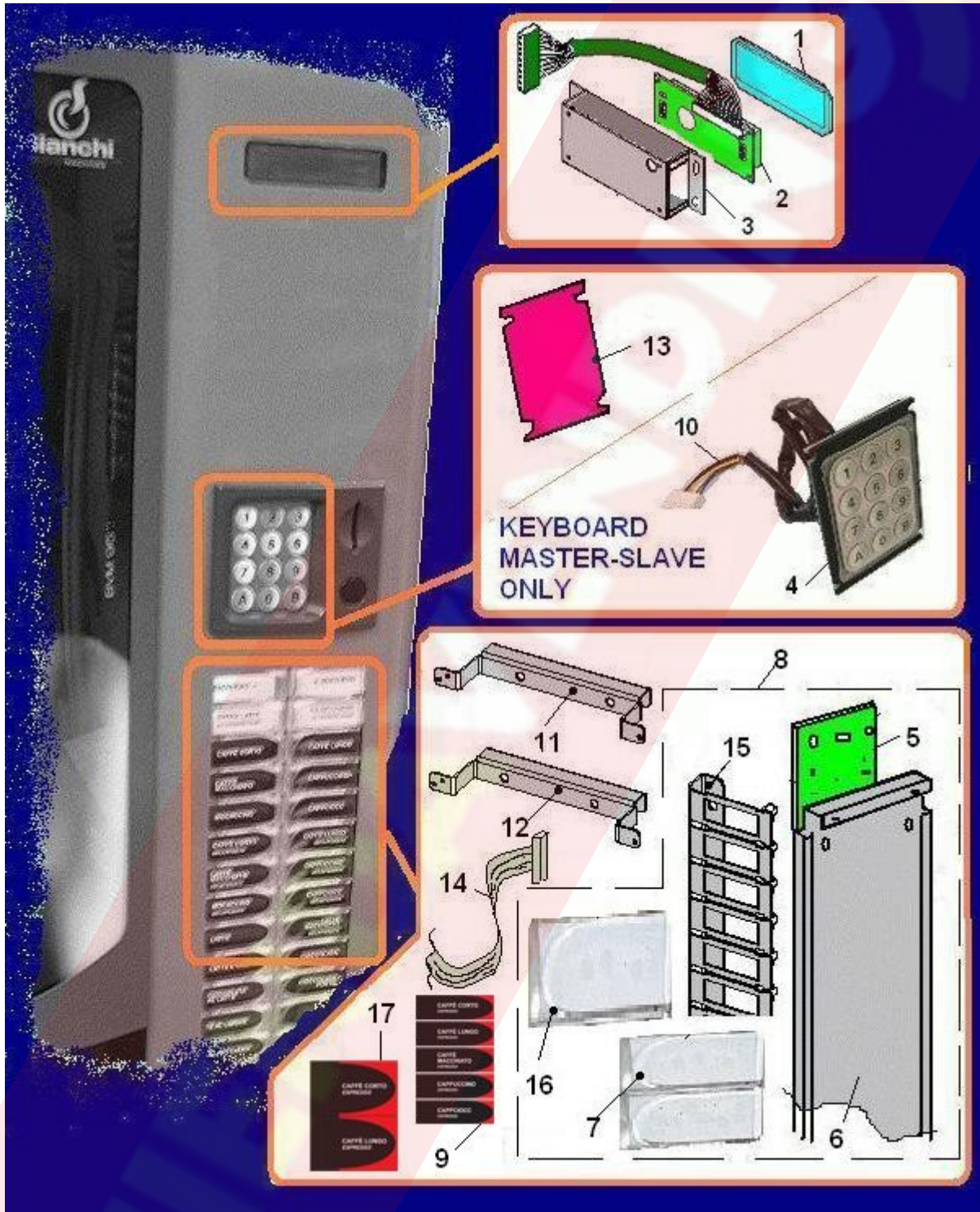

## PULSANTIERA - VISUALIZZATORE (825) - Detalle de los artículos

| POSICIÓN | CODIGO DE REPUESTO Accesorios | DESCRIPCIÓN                    | Para cada artículo principal multiplique q.ty cerca |
|----------|-------------------------------|--------------------------------|---|
| 1        | 05232515M00                   | VETRINO DISPLAY                |   |
| 2        | 26047916                      | nuevo display 16x2             |   |
| 3        | 01793011-01                   | LAMIERA SUPPORTO DISPLAY       |   |
| 4        | 30100926                      | PULSANTIERA M/S IN METAL.A e   |   |
| 5        | 26048016                      | SCHEDA PULSANTIERA BVM951/971  |   |
| 6        | 01795112                      | ASS.LAMIERE PULSANTIERA        |   |
| 7        | 05232415M00                   | PULSANTE SELEZIONE             |   |
| 8        | 26048250                      | ASS. PULSANTIERA BVM 972 DC DM |   |
| 9        | 30262811                      | ETICHETTE SELEZIONE BVM951/97  |   |
| 10       | 22170812                      | FLAT TAST. NUM.METAL. AB VEGA  |   |
| 11       | 01827011                      | SUPP.PULSANTIERA SUP.BV971 IVS |   |
| 12       | 01827111                      | SUPP.PULSANTIERA INF.BV971 IVS |   |
| 13       | 01806311                      | PIASTRINA RINF.FERITOIA M/S    |   |
| 14       | 22175422                      | FLAT CABLE 16 VIE L=900mm      |   |
| 15       | 01793711                      | LAMIERA SUPPORTO PULSANTI      |   |
| 16       | 05237015M00                   | PULSANTE SELEZIONE DOPPIO      |   |
| 17       | 30269511                      | ETICHET.SELEZIONE BV952/972 DM |   |



Tabla: MOLINO (816)

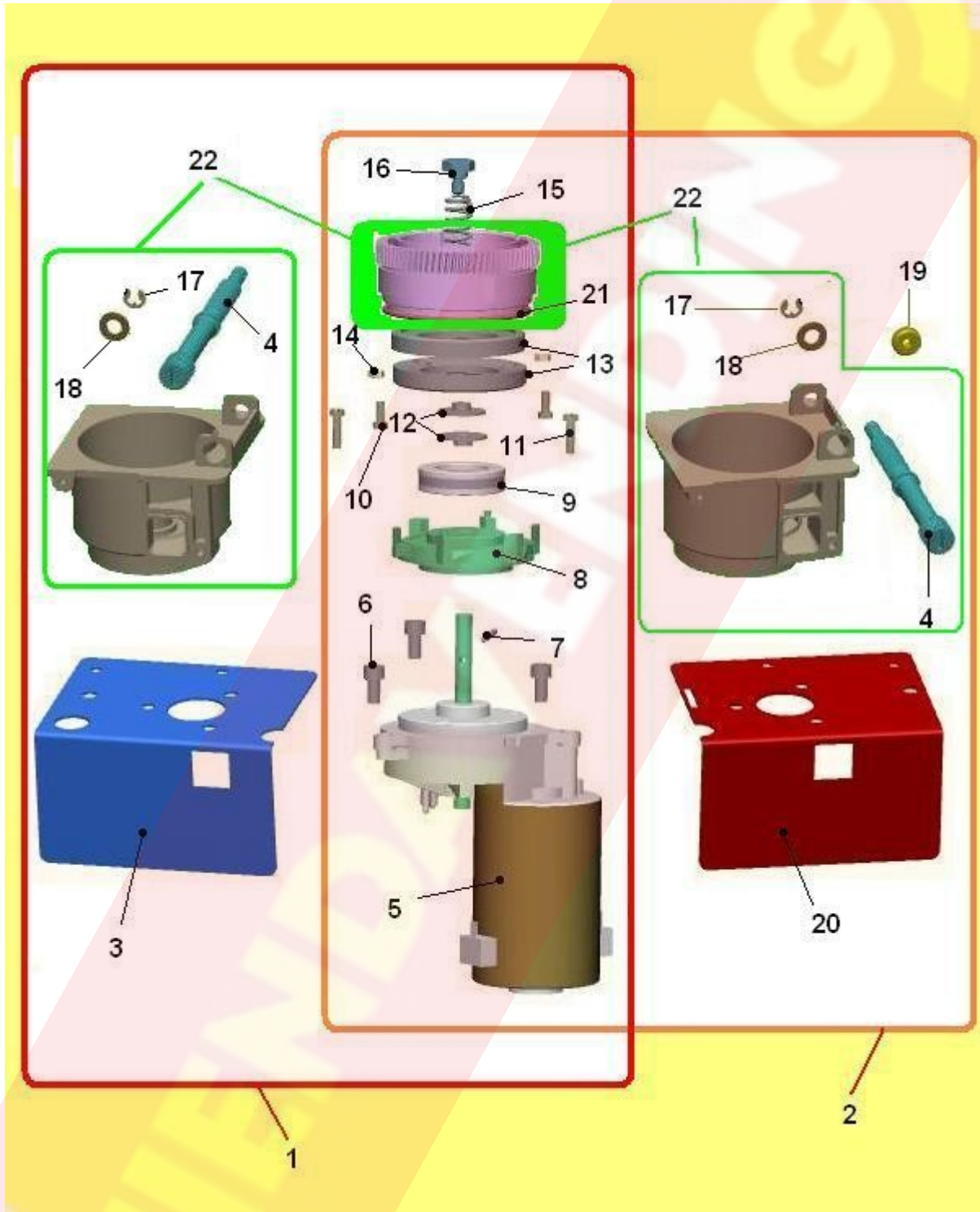

## MOLINO (816) - Detalle de los artículos

| POSICIÓN | CODIGO DE REPUESTO | Accesorios | DESCRIPCIÓN                    | Para cada artículo principal multiplique q.ty cerca |
|----------|--------------------|------------|--------------------------------|---|
| 1        | 86001350           |            | ASS.MACININO CAFFE SX BVM 972  |   |
| 2        | 86001340           |            | ASS. MACININO CAFFE DX BVM 972 |   |
| 3        | 01890721           |            | PIASTR. FISS. MACININO SX      |   |
| 4        | 05134715           |            | sujetador regulac. muela       |   |
| 5        | 20020616           |            | MOTORE XMACININO AMETEK 24VCC  |   |
| 6        | 32135316           |            | VITE TCEI 6MAX12 ZN            |   |
| 7        | 12017411           |            | alambre D3x30                  |   |
| 8        | 13008211-02        |            | PORTAMACINE MOBILE             |   |
| 9        | 19059216           |            | cojinete axial                 |   |
| 10       | 32060516           |            | VITE TC 4MAX10                 |   |
| 11       | 32060816           |            | VITE TC 4MAX16                 |   |
| 12       | 19060411           |            | RONDELLA CON BUSSOLA           |   |
| 13       | 18007316-01        |            | muela molinillo dm.64          |   |
| 14       | 34102816           |            | tuerca es. 4ma zin.            |   |
| 15       | 07020411           |            | resorte de molinillo           |   |
| 16       | 19059021           |            | tornillo resorte mol.ametek    |   |
| 17       | 37001116           |            | anillo seeger Ø 6              |   |
| 18       | 35168826           |            | ROND-PIANA D.8,4x15,5x1,2±0,0  |   |
| 19       | 23004086           |            | PASSACAVO DM. 6X15 GOMMA       |   |
| 20       | 01890711           |            | PIASTR. FISS. MACININO DX      |   |
| 21       | 36211316           |            | OR 3262 nbr 70 sh              |   |
| 22       | 43018910-01        |            | ASS.CAMERA MACINATURA C/POMOLO |   |

Tabla: COMPONENTI PER MISCELATORI (823)

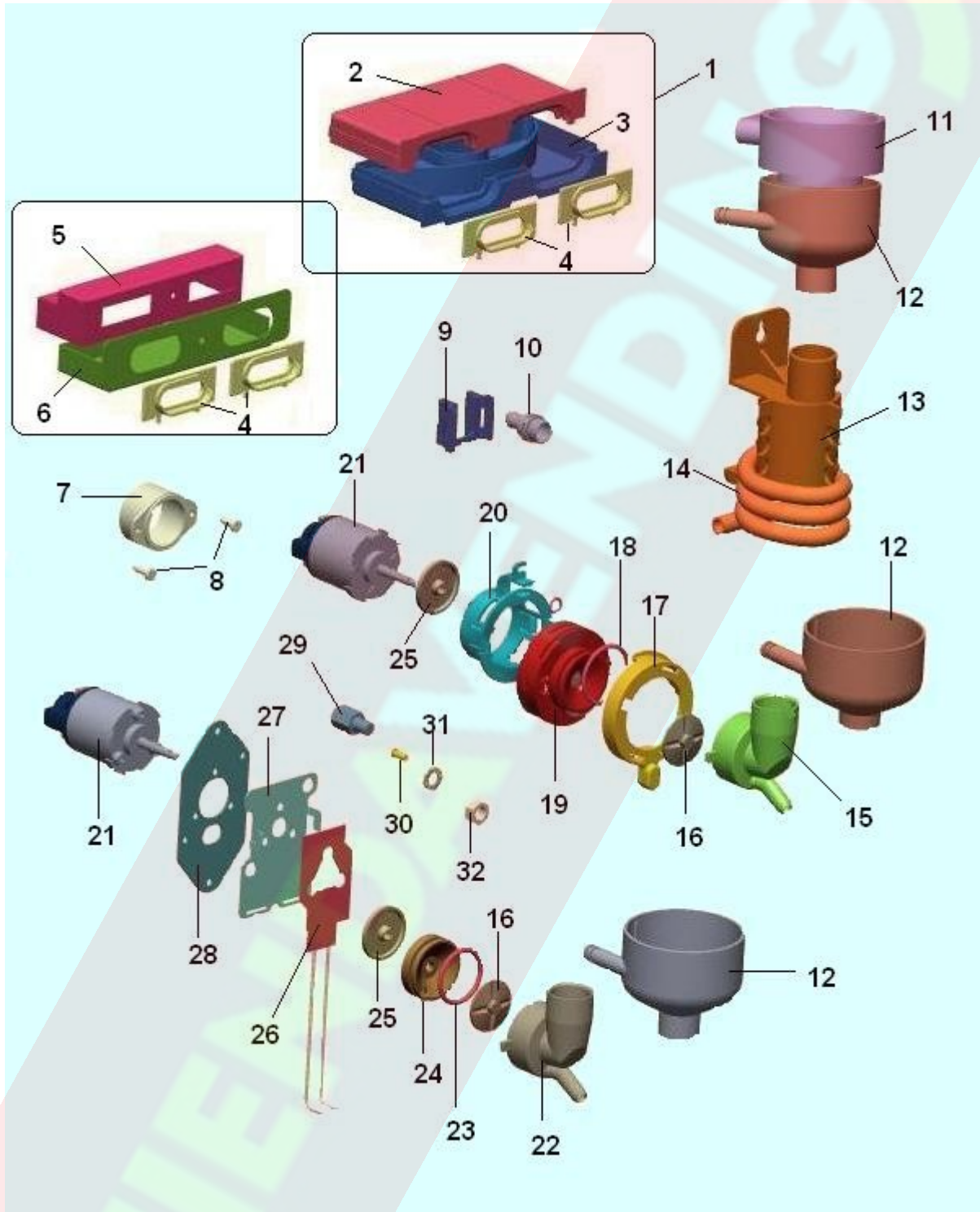

## COMPONENTI PER MISCELATORI (823) - Detalle de los artículos

| POSICIÓN | CODIGO DE REPUESTO | Accesorios | DESCRIPCIÓN                    | Para cada artículo principal multiplique q.ty cerca |
|----------|--------------------|------------|--------------------------------|---|
| 1        | 05169010           |            | gaveta aspiracion inf.         |   |
| 2        | 05139725           |            | gaveta aspiracion sup.         |   |
| 3        | 05139625           |            | CASSET.INF.ASP.PEG IVS MARRONE |   |
| 4        | 05117615           |            | boca conj. aspiracion. vap     |   |
| 5        | 01886211           |            | CORPO SUPERIORE CAMERA ASPIR.  |   |
| 6        | 01886311           |            | CORPO INFERIORE CAMERA ASPIR.  |   |
| 7        | 05071915           |            | boca x aspir.                  |   |
| 8        | 32222956           |            | tornillo autorroscante 3,9     |   |
| 9        | 05159025M37        |            | SUPP.INNESTO PORTAGOMMA MARRON |   |
| 10       | 05088915M57        |            | RACCORDO PORTAGOMMA NERO AM    |   |
| 11       | 05113815M57        |            | COPER.ASPIRA.(MISC.BIA)NERO AM |   |
| 12       | 05113745M57        |            | copa mezcla sprint L= 10       |   |
| 13       | 05141815M57        |            | SUPP. SERPENT.THE PLS NERO AM  |   |
| 14       | 09087823M57        |            | TUBO SILICONE 5X9 NERO AM      |   |
| 15       | 05111615M57        |            | CAMERA MISC.(BIANCHI) NERO AM  |   |
| 16       | 05111825           |            | girante copa precalentad.      |   |
| 17       | 05240915M37        |            | FLANGIA BLOCCAGGIO CAMERA      |   |
| 18       | 36210716           |            | guarnic. OR 3131 sil.          |   |
| 19       | 05243112M57        |            | ASS.FLANGIA SUPPORTO CAMERA AM |   |
| 20       | 05241115-01M37     |            | FLANGIA SUPPORTO MOTORE        |   |
| 21       | 20020016-01        |            | MOTOFR.24V.DC ALB-FILET.S/CABL |   |
| 22       | 05137615           |            | camara mezcla en ver-ton       |   |
| 23       | 36212516           |            | O-Ring 29,74x2,95 viton        |   |
| 24       | 19033441           |            | BASE X FRULLATORE NUOVA        |   |
| 25       | 05154015           |            | disco proteccion               |   |
| 26       | 29004216           |            | resistencia 20W 24V            |   |
| 27       | 01830711           |            | SUPPORTO COPPETTA RISCALDATA   |   |
| 28       | 01830812           |            | SUPP.ASS.COPPETTA RISC.C/INSE  |   |
| 29       | 19056531-01        |            | tuerca bloque L=26,5           |   |
| 30       | 32238036           |            | PRIG. M4X10 PEM ZN             |   |
| 31       | 35160616           |            | arandela dent.d.8,3 br.        |   |
| 32       | 34103116           |            | tuerca es. 8ma zin.            |   |

Tabla: POMPA ACQUA - RILEVATORE DI FLUSSO (830)

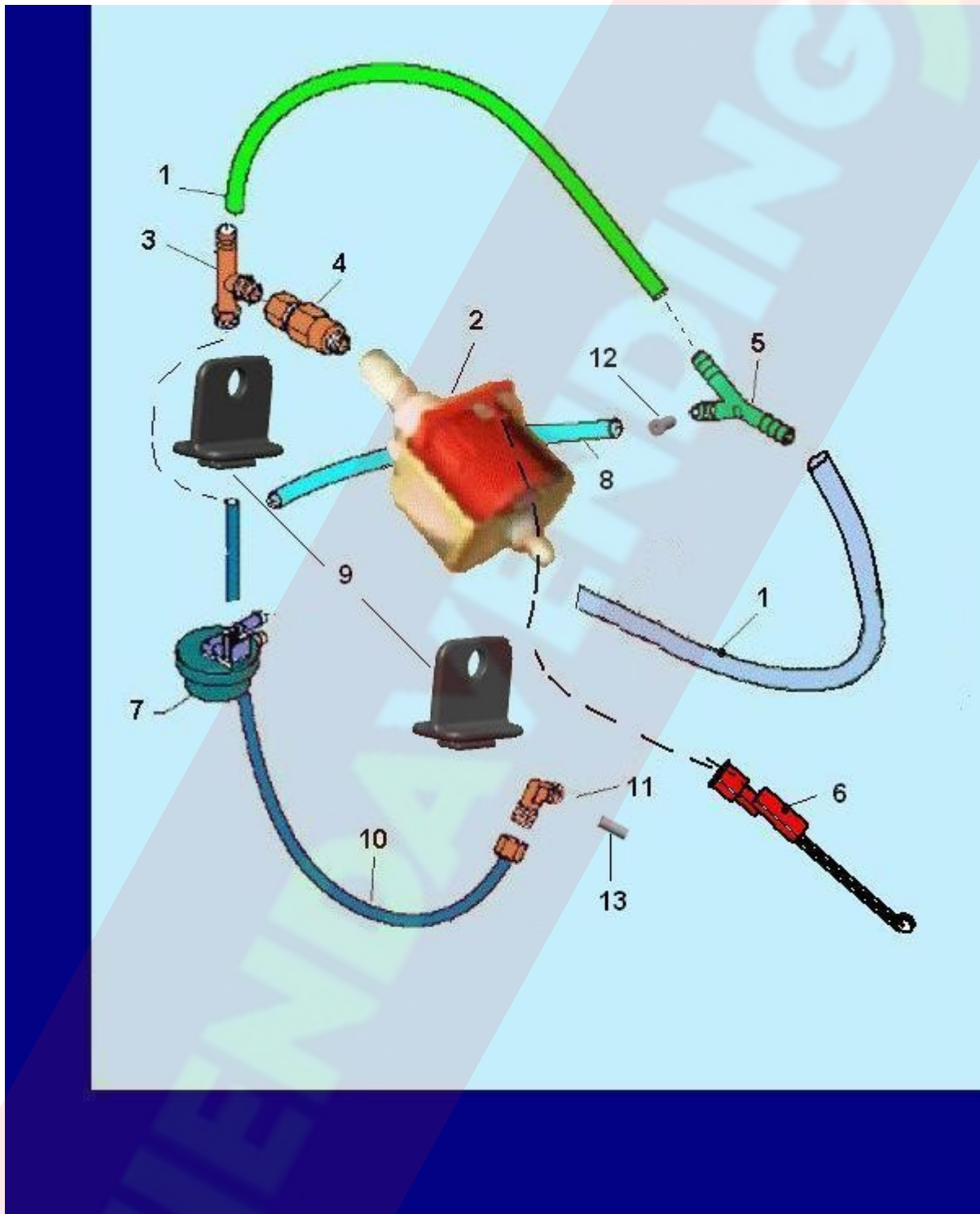

## POMPA ACQUA - RILEVATORE DI FLUSSO (830) - Detalle de los artículos

| POSICIÓN | CODIGO DE REPUESTO | Accesorios | DESCRIPCIÓN                    | Para cada artículo principal<br>multiplique q.ty cerca |
|----------|--------------------|------------|--------------------------------|--|
| 1        | 09087823M57        |            | TUBO SILICONE 5X9 NERO AM      |  |
| 2        | 27003316           |            | electrobomb ulka ex5 230V-50Hz |  |
| 3        | 04040916-01        |            | valvula de seguridad           |  |
| 4        | 04041016           |            | valvula de no retorno          |  |
| 5        | 05240015M00        |            | racorde 3 vie D.exterior 9 mm  |  |
| 6        | 25022616           |            | CLIXON MICROTHERM F11 100°     |  |
| 7        | 24012116           |            | contador volumetrico           |  |
| 8        | 09029763           |            | tubo silicona transparente     |  |
| 9        | 05259515M09        |            | SUPP. POMPA ULKA/FLUIDOTECH    |  |
| 10       | 09085423           |            | tubo teflon d4x6               |  |
| 11       | 04035326           |            | codo art.237 6-1/8             |  |
| 12       | 05102215M57        |            | RIDUT.CAM-MISCELAZ. NERO AM    |  |
| 13       | 19004326           |            | anillo de refuerzo.art.247     |  |

Tabla: COMPONENTI ELETTROVALVOLA SOLUBILI (832)

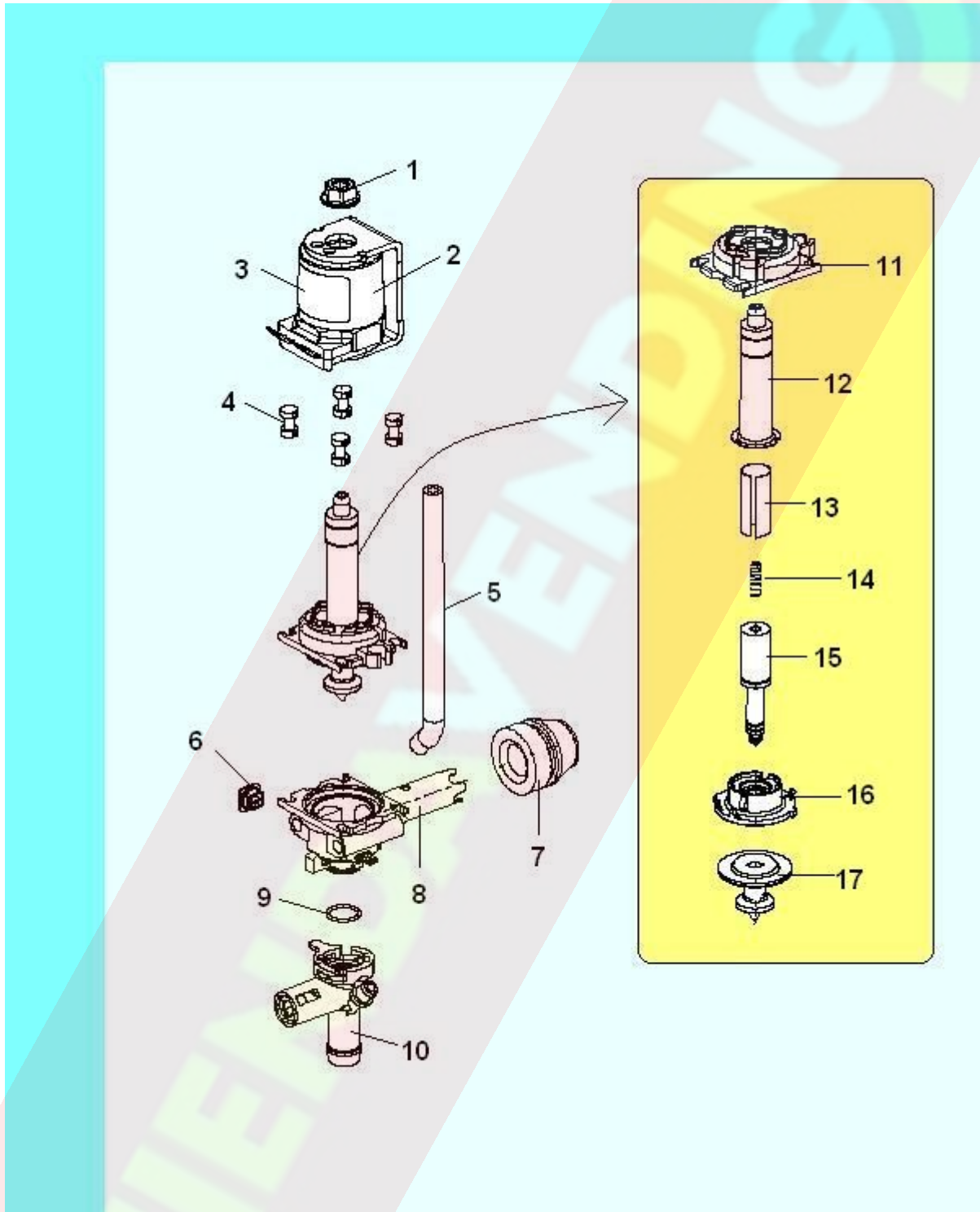

## COMPONENTI ELETTROVALVOLA SOLUBILI (832) - Detalle de los artículos

| POSICIÓN | CODIGO DE REPUESTO | Accesorios | DESCRIPCIÓN                    | Para cada artículo principal<br>multiplique q.ty cerca |
|----------|--------------------|------------|--------------------------------|--|
| 1        | 43050216           |            | DADO                           |  |
| 2        | 43050016           |            | BOBINA COMPLETA                |  |
| 3        | 43050116           |            | TARGHETTA                      |  |
| 4        | 43049916           |            | MORSETTE DI ARRESTO            |  |
| 5        | 43050316           |            | TUBO DI VENTILAZIONE           |  |
| 6        | 43049016           |            | MORSETTA D'ARRESTO             |  |
| 7        | 43050416           |            | GUARNIZIONE/MANICOTTO          |  |
| 8        | 43048816           |            | CORPO CON SEDE DI TPFE         |  |
| 9        | 43049116           |            | O-RING                         |  |
| 10       | 43048916           |            | BECCUCCIO,VITE REGOLAT, O-RING |  |
| 11       | 43049816           |            | PIASTRA DI ARRESTO             |  |
| 12       | 43049716           |            | CANOTTO CON INSERTO            |  |
| 13       | 43049616           |            | FOGLIO DI SCORRIMENTO          |  |
| 14       | 43049516           |            | MOLLA                          |  |
| 15       | 43049216           |            | NUCLEO                         |  |
| 16       | 43049316           |            | SOSTEGNO GUARNIZIONE           |  |
| 17       | 43049416           |            | MEMBRANA                       |  |



Tabla: COMPONENTI SCATOLA ORZO/CAFFE (908)

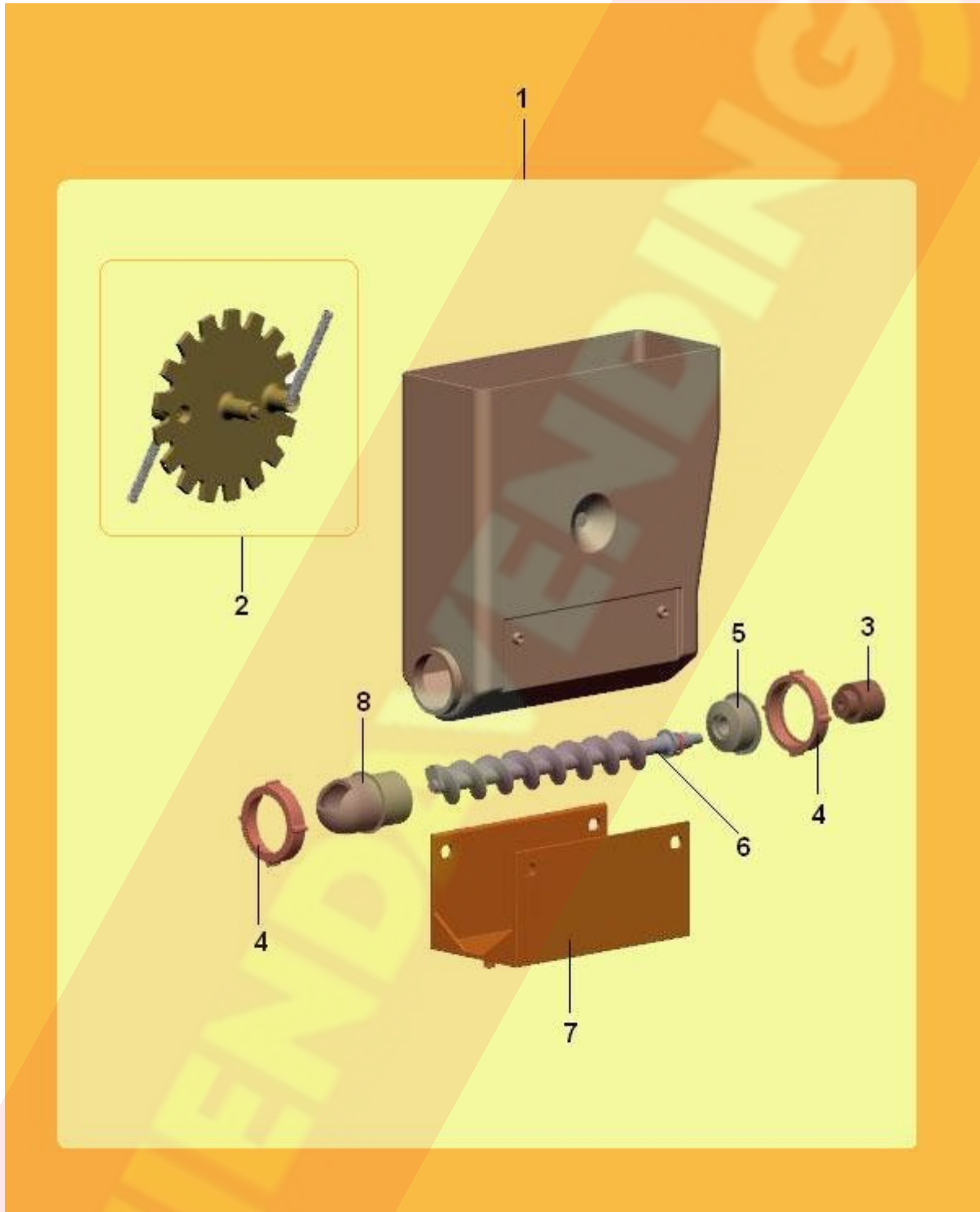

## COMPONENTI SCATOLA ORZO/CAFFE (908) - Detalle de los artículos

| POSICIÓN | CODIGO DE REPUESTO Accesorios | DESCRIPCIÓN                    | Para cada artículo principal multiplique q.ty cerca |
|----------|-------------------------------|--------------------------------|---|
| 1        | 05203320                      | SCAT.DOS. S/COPERCHIO BVM300   |   |
| 2        | 43017516                      | RUOT.D.22,5 NSF+MOLLE201A0519B |   |
| 3        | 43017416                      | NOTTOLINO L20 101A0505B        |   |
| 4        | 43017116                      | GHIERA BLOCC.FLANG.NSF101A049A |   |
| 5        | 43017216                      | FLANGIA POST.D.27 NSF101A0492B |   |
| 6        | 43017016                      | ASS.COCLEA TN CIOCC.201A0510B  |   |
| 7        | 43097116                      | POPPETTA POSIZ.IN AVANT.SC-DOS |   |
| 8        | 43017316                      | FLANG.ANT.LUNET.D.27 101A049AC |   |

TIENDA VENTURA