

Pos.	Referencia	Denominación
1	43235060	MAZO INTERRUPTOR FILTRO HUSILLOS R290
2	43234910	MAZO INTERF. BALDAS PALMA H R R290
3	43130020	CTO. MAZO SONDA T PALMA H R290
4	43134700	CTO. TARJETA BALDA 6 TROPICALIZADA R290
5	43134710	CTO. TARJETA BALDA 8 TROPICALIZADA R290
6	09728350	COMPRESOR HUAYI NUY70RAa
7	41251501	CTO. VENTILADOR GRUPO PALMA R290
8	04800150	FUSIBLE TEMPORIZADO TIPO "T" 6,3A
9	4330758000	TARJETA POTENCIA PALMA
9	4330758001	TARJETA POTENCIA PALMA 240V
10	43210470	MAZO CONTROL RELES GF.
11	4310586000	CTO. TRANSFORMADOR PALMA
12	43210450	MAZO BUS ALIMENTACION PALMA
13	43210460	MAZO BUS CONTROL PALMA
14	11017870	CASQUILLO TRANSFORMADOR
15	43210500	MAZO PULSADORES PALMA
16	43210490	MAZO DISPLAY PALMA
17	41005771	CJTO.CAJA DE PROGRAMACION
18	43210550	MAZO INTERF.CAJA PROGRAM.
19	43307610	TARJETA ENTRADA SALIDA HUSILLO
20	43319910	TARJETA NUEVA DISPLAY PALMA HUSILLOS AZ
21	43223030	MAZO CONEXION DISPLAY LCD
22	43315550	DISPLAY LCD CON CONECTOR 16X2 (AV 99X24)
23	41078981	CTO. TECLADO PALMA
24	43221000	MAZO INTERF. BALDAS PALMA H R
25	41159990	CTO.TARJETA FLASH 5206+RAM
25	43312590	TAR. CONTROL COMUN FLASH 5206E
26	43210820	MAZO RS232 PC-CONTROL COMUN
27	43312600	TARJETA MEMORIA DATOS
28	43233830	MAZO ADAPTADOR ALIMENTACION MDB-EXE
29	43317160	TARJETA CONTROL NUEVO IDETECT
30	41142921	CTO.TARJ.DETEC.LADO BISAG.PALH
31	41142911	CTO.TARJ.DETEC.LADO MONED.PALH
32	43211850	MAZO G.F. E ILUM. SUP. PALMA H
33	43124100	CTO. MAZO ILUMINACION LED PALMA 24V
34	43212150	MAZO MANGUERA PALMA FILTRO

Pos.	Referencia	Denominación
34	43212210	MAZO MANGUERA PALMA FILTRO GB.
34	43212220	MAZO MANGUERA PALMA FILTRO aus
34	43212450	MAZO MANGUERA PALMA FILTRO ZA.
35	09702450	SUJETACABLES ITW 0163-010-10
36	04802700	RFI FILTRO X-Y 10A 250V
37	04000510	INTERRUPTOR IL-902AN/220V.ROJO
38	04801500	PORTAF.WICKMANM 19823+19837
39	04801580	FUSIBLE TEMPORIZADO TIPO T 10A
41	09720300	FUENTE ALIMENTACIÓN +24V 60W

TIENDA VENDING

PALMA Hz

A7000401



Pos.	Referencia	Denominación
1	31107330	DESAGÜE SUPERIOR PALMA Z
2	04200920	SOPTE.FLUORESC.BJB 26726015050
3	41119181	CTO.SPTE.FLUORESCENTE GR.HZ
3	41119191	CTO.SPTE.FLUORESCENTE PQ. HZ
3	41119201	CTO.SPTE.FLUORESCENTE GR.MZ
4	31096261	SOPORTE FLUORESCENTE 30W B5
5	04200900	FLUORESC.PL-L PRO 36W/840 4P
6	19022151	CRISTAL DOBLE GR. PALMA Z
6	19022161	CRISTAL DOBLE PQ. PALMA Z
6	19071821	CRISTAL DOB.GR. PALMA HZ87 CON ARGON
7	11021561	SOP. CAJA PROGRAMACION
10	42924860	SUBC.EMBELLECEDOR IZD.HZ
11	31106850	BRIDA IZDA.CRISTAL PALMA Z
12	31107450	SOPTE. CAJON PALMA MZ
13	31081150	BIELA APERTURA PALMA
14	00002131	TUER.HEX.AUTOBL. DIN985 M5 BL
15	10006181	TORNILLO PIVOTE PUERTA
16	3109219100	SOPTE DCHO.ELECTRÓNICA H/M NEG
17	10012561	EJE RESBALON RUEDA B6-G
18	11012721	MARCO CAJETIN
18	11034211	MARCO SIN ABRIDOR
18	11034212	MARCO SIN ABRIDOR NEGRO
19	11000151	RUEDA RESBALON
20	31092040	SOPORTE RESBALON B6-G.
21	42102213	SUBC.PUERTA GR. PALMA Z
21	42102223	SUBC. PUERTA PQ PALMA Z NEGRO
21	42103251	SUBC. PUERTA GRANDE PALMA Z II NEGRO
22	41118911	CTO.BARRA CIERRE PALMA Z
22	41205531	CTO. BARRA DE CIERRE PALMA Z II
23	11038501	ESCUDO ENTRADA MONEDAS
24	08500410	CERRAJA STS 623.093
24	08500830	CERRAJA STS 623.091 SUELTA
24	08501510	CERRAJA STS 623093 CROMADA P
24	08501540	CERRADURA AMA. CIH 862600008417
24	08501970	CERRAJA STS 62305000413 LL.IGUALES 52312
25	31102521	MANIVELA CIERRE PAL.ANTI-PALAN

Pos.	Referencia	Denominación
26	42904401	SUBC.BIELA CIERRE CINCADA
27	31106660	SUPLTO. BARRA DE CIERRE
28	31068170	EMBOCADURA
29	31107111	SOPTE. GUIAMONEDAS ENTRADA
30	39015890	GUIAMONEDAS ENTRADA PALMA Z
31	42502151	SUBC.GUIAMON.RECUP.PALMA Z
31	42525881	SUB. GUIAMONEDAS DEV. PALMA Z II NEGRO
32	31107160	DEFLECTOR GUIAMONEDAS RECUPER.
33	4291575100	SUBC. HUCHA
34	31107171	SOPTE. HUCHA PALMA Z
35	31107181	SOPTE. SUP. HUCHA PALMA Z
36	31072240	SOP.CAJETIN RECUPERACION
37	11023021	CAJETIN RECUPERACION PALMA
37	11029651	CAJETIN RECUPERACION
38	11029661	VAIVEN
38	31076580	VAIVEN CHAPA
39	04200910	PORTAFLUORESCENTE
40	04200000	CEBADOR 22-65W 220-240V
41	04200380	PORTACEBADOR BSB 26.514.500050
42	10011371	CASQUILLO GUIA CIERRE
43	19022141	PROTECTOR CRISTAL NEGRO PAL.Z

TIENDA VENDING

PALMA Hz

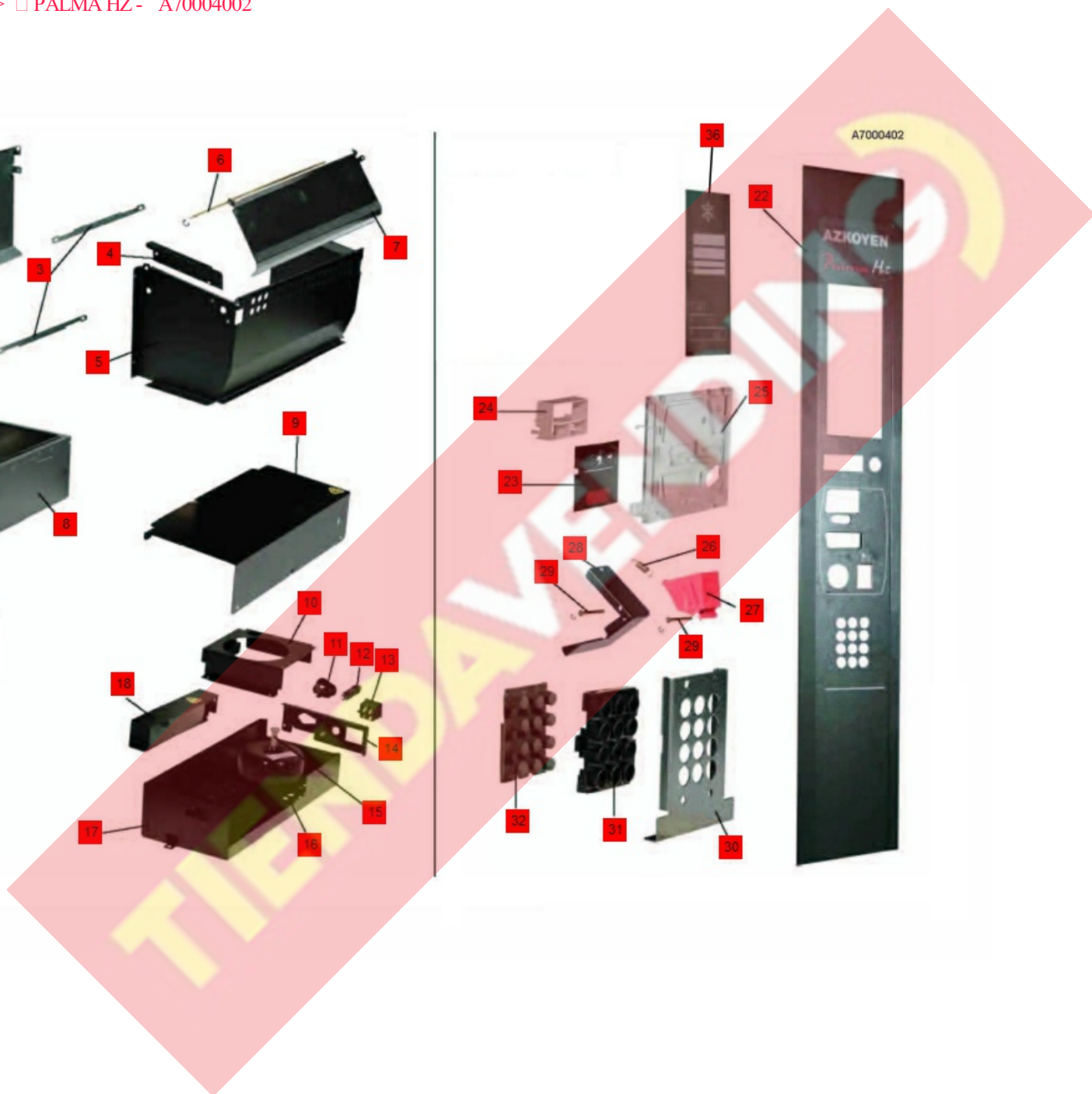
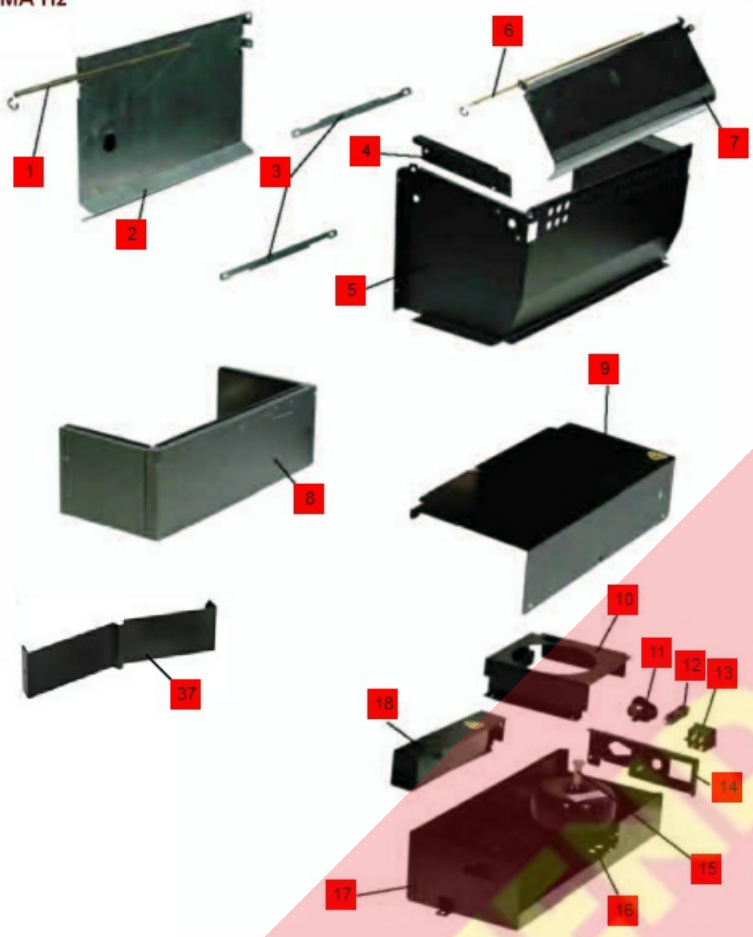

Pos.	Referencia	Denominación
1	10015011	EJE VAIVEN GR PALMA Z
1	10015021	EJE VAIVEN PQ PALMA Z
2	42924761	SUBC.VAIVEN GR PALMA HZ
2	42924771	SUBC.VAIVEN PQ PALMA HZ
3	31106940	BIELA ANTIRROBO PALMA Z
4	31117491	SOPTe.iDETECT LADO BISAG.HZ MZ
5	31117531	ANTIRROBO HZ GRANDE iDETECT
5	31117541	ANTIRROBO HZ PEQ. iDETECT
6	10015031	EJE VAIVEN ANTIRROBO GR HZ
6	10015041	EJE VAIVEN ANTIRROBO PQ HZ
7	31106951	VAIVEN ANTIRROBO PALMA HZ GR.
7	31106961	VAIVEN ANTIRROBO PALMA HZ PQ.
8	42924971	SUBC. CAJON GRANDE PALMA Z
8	42924981	SUBC. CAJON PEQUEÑO PALMA Z
9	3109212100	TAPA CAJON ELECTRONICA M/H NEG
10	3109218100	TAPA TRANSFORMADOR NEGRA
11	09702450	SUJETACABLES ITW 0163-010-10
12	04801500	PORTAF.WICKMANM 19823+19837
13	04000510	INTERRUPTOR IL-902AN/220V.ROJO
14	4292163100	SUBC.SOPORTE INTERRUPTOR PALMA
15	11017870	CASQUILLO TRANSFORMADOR
16	4310586000	CTO. TRANSFORMADOR PALMA
17	4292151100	SUB. CAJA ELECTRONICA NEGRA
18	3109217100	SOPORTE REACTANCIA NEGRO 9005
22	42923642	SUB.PANEL PALMA HZ NEGRO
22	42947901	SUB. PANEL PALMA Z II GRIS
23	19022771	ROTULO MONEDAS PALMA Z
24	11019401	VISOR DISPLAY
24	19062031	VISOR DISPLAY PALMA II
25	41118701	CTO.PANEL DISPLAY PALMA HUSILL
26	12001310	MUELLE LENGUETA AGOTADO
27	39014210	BOTON DE RECUPERACION MINI
28	31102171	CHAPA RECUPERACION PALMA Z
29	10012641	EJE PANEL
30	31060900	TOPE TECLADO
31	11014551	GUIA TECLADO

Pos.	Referencia	Denominación
32	11014560	MEMBRANA TECLADO
36	31126911	FRONTAL ETIQUETA GENERAL
36	31126912	FRONTAL ETIQUETA GENERAL GRIS ALUM
36	41175031	CTO.FRONT.ETIQ.GEN.PAL.NEGRA C
36	41175041	CTO. FRONTAL LECTOR BILLETES
36	41236081	CTO. FRONTAL LECTOR BILLETES GRIS
37	31108111	BASE CAJON BOTELLAS HZ 87
37	31108121	BASE CAJON BOTELLAS HZ70

TIENDA VENDING

PALMA Hz

A7000403

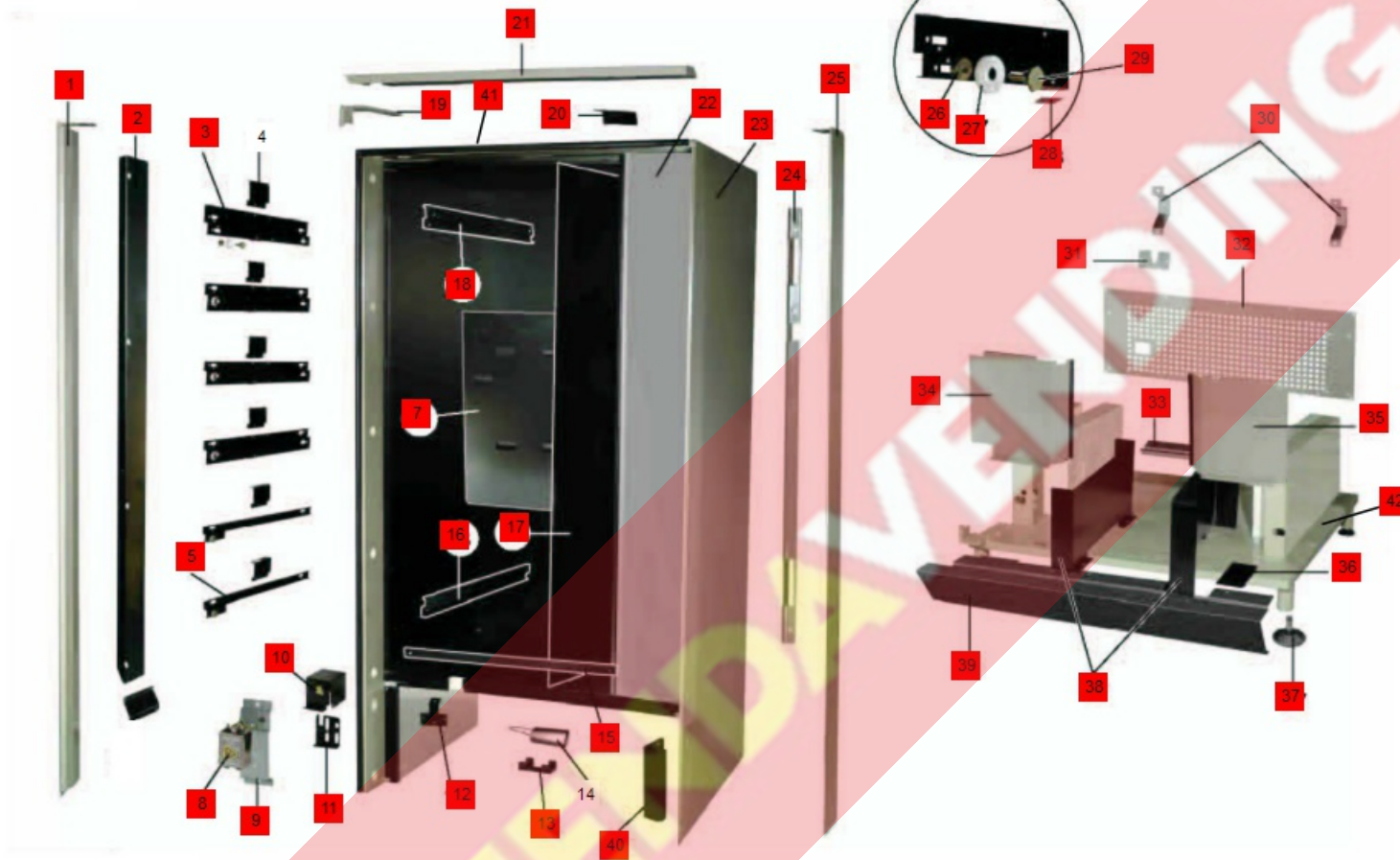

Pos.	Referencia	Denominación
1	42924733	SUBC.ANTIPALANCA DCHO PALMA Z
2	31108391	DEFLECTOR MUEBLE PALMA Z
3	41126001	CTO.GUIA BALDA SUP.DCHO PAL.Z
5	41126021	CTO.GUIA BALDA INF.DCHO HZ
7	3107297101	DIFUSOR AIRE HUSILLOS
8	04802350	FILTRO DE RED PREFILTER FF-6Z
9	31084520	SOPORTE FILTRO
10	3107700100	TAPA CONECTORES HUSILLOS
11	3107513100	SOP. CONECTORES CUBA HUSILLOS
12	3107678100	TAPA TUBO Y CABLE PALMA
13	11021561	SOP. CAJA PROGRAMACION
15	31106531	TRAVESAÑO G.FRIO PALMA GR HZ
15	31106541	TRAVESAÑO G.FRIO PALMA PQ HZ
16	41126031	CTO.GUIA BALDA INF.IZDO HZ
17	31106551	TABIQUE IZDO. PALMA GR. HZ
17	31106561	TABIQUE IZDO. PALMA PQ. HZ
18	41126011	CTO.GUIA BALDA SUP.IZDO PAL.Z
19	4291562102	SUBCTO.BISAGRA SUPERIOR MUEBLE
20	3107481102	TOPE CERRADURA SUPERIOR NEGRO
21	4291553102	SUBC.ANTIPALANCA SUP.GRANDE
21	4291554102	SUBC.ANTIPALANCA SUP.PEQ.NEGRO
22	42102330	SUBC.PUERTA INTERIOR PALMA Z
23	41125853	CTO.MUEBLE GR PALMA HZ NEGRO
23	42003533	SUBC.MUEBLE INY PEQUEÑO HZ NEG
24	3107481102	TOPE CERRADURA SUPERIOR NEGRO
25	42924743	SUBC.ANTIPALANCA IZDO PALMA Z
26	10011881	SUPLEMENTO RUEDA RESBALON
27	11000151	RUEDA RESBALON
28	39006241	TOPE LIMITADOR PROFUNDIDAD
29	10011231	EJE RUEDAS BALDA
30	31022820	SEPARADOR PARED
31	3107513100	SOP. CONECTORES CUBA HUSILLOS
32	31106500	TAPA RESPALDO MUEBLE GR.PAL.Z
32	31106510	TAPA RESPALDO MUEBLE PQ.PAL.Z
33	31072990	BRIDA GRUPO DE FRIO
34	31092330	CIERRE DCHO.PEQ.GRUPO DE FRIO

Pos.	Referencia	Denominación
34	31092340	CIERRE DCHO.GRAN.GRUPO DE FRIO
35	31092310	CIERRE IZDO.PEQ.GRUPO DE FRIO
35	31092320	CIERRE IZDO.GRAN.GRUPO DE FRIO
36	11011281	RESBALON MUEBLE
37	42910961	CTO.NIVELADOR NEGRO
38	31076640	TAPA CONTRAPESO GRANDE
38	31076650	TAPA CONTRAPESO PEQUEÑA
39	3107662100	ZOCALO MUEBLE GRANDE NEGRO
39	3107663100	ZOCALO MUEBLE PEQUEÑO NEGRO
40	3107482102	TOPE CERRADURA INFERIOR NEGRO
41	41147151	CTO.SUPLEMENTO TECHO
42	42923843	SUBC.BASE MUEBLE H/M 70 NEGRO

TIENDA VENDING

PALMA Hz

A7000404

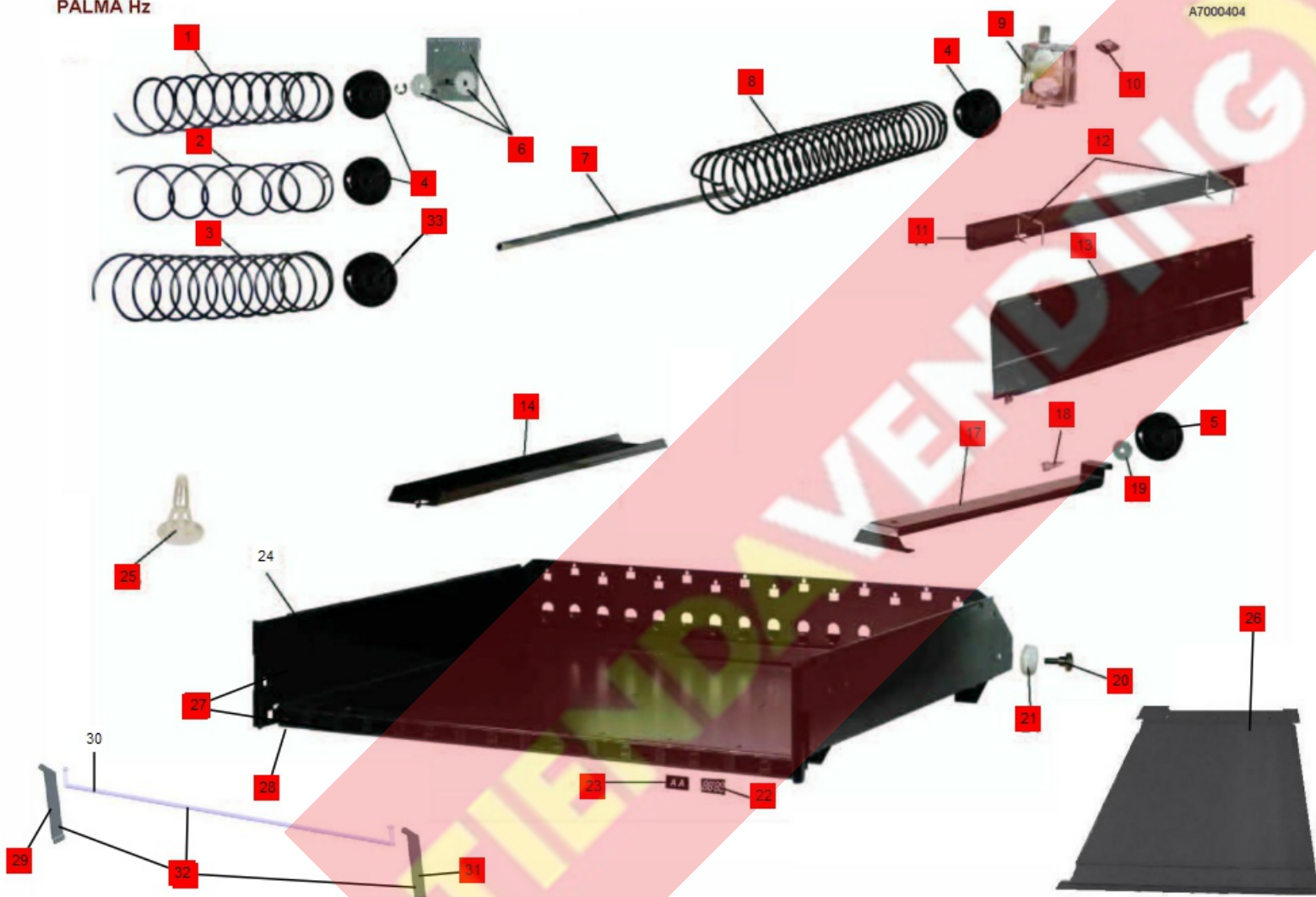

Pos.	Referencia	Denominación
1	1901506101	HUSILLO 65C 40 NEGRO
1	1901507101	HUSILLO 65C 50 NEGRO
1	1901508101	HUSILLO 65C 60 NEGRO
1	1901644101	HUSILLO 65X25 C NEGRO
1	1901645101	HUSILLO 65C 30 NEGRO
1	1901646101	HUSILLO 65X35 C NEGRO
2	1901489101	HUSILLO 78 35 NEGRO
2	1901490101	HUSILLO 78 45 NEGRO
2	1901491101	HUSILLO 78 55 NEGRO
3	1901482101	HUSILLO 65 20 NEGRO
3	1901483101	HUSILLO 65 25 NEGRO
3	1901484101	HUSILLO 65 30 NEGRO
3	1901485101	HUSILLO 65 35 NEGRO
3	1901486101	HUSILLO 65 40 NEGRO
3	1901487101	HUSILLO 65 50 NEGRO
3	1901488101	HUSILLO 65 60 NEGRO
3	1901548101	HUSILLO 65 85 NEGRO
4	11019201	GUIA HUSILLO 65 (SPIRAL END CUP)
4	11035201	GUIA HUSILLO 65 CORTO
5	11035201	GUIA HUSILLO 65 CORTO
6	41132621	CTO.TRASM.HUSILLO CONTRAR.BP
7	19016380	DIVISOR HUSILLO
8	1901514101	HUSILLO 65D 20 NEGRO
8	1901515101	HUSILLO 65x30 D-GR. NEGRO
9	41081031	CTO. REDUCTORA HUSILLOS
10	43310300	TARJETA MICRO FIN CARRERA PALM
11	31089221	REGULADOR LATERAL PRODUCTO
12	19018091	SOPORTE REGULADOR LATERAL
13	1101916102	TABIQUE SEPARADOR NEGRO
13	11037241	TABIQUE LATAS-BOTELLAS H
13	4109602102	CTO.TABIQUES BOTES NEGRO
14	3107254101	GUIA INFERIOR HUSILLO LARGO
17	11037291	SOPORTE BOTES-BOTELLAS H
18	01015051	TORN. ALOM. PARA PLÁSTICOS 4x10
19	31075860	TOPE SOPORTE BOTES
20	10011231	EJE RUEDAS BALDA

Pos.	Referencia	Denominación
21	11000151	RUEDA RESBALON
22	19016401	ROTULO PRECIO PALMA
23	19016391	ROTULOS DE PRODUCTO PALMA
25	09703050	PILARETE CRLCBSRE-4-01
26	31118261	SEPARADOR 2 TEMP. BALDA 8C
26	31118271	SEPARADOR 2 TEMP. BALDA 6C
27	41206191	CTO. BALDA REFUERZO+PERFIL 8 CANALES
27	41206201	CTO. BALDA REFUERZO+PERFIL 6 CANALES
28	31118111	REFUERZO INFER.BALDA 8 CANALES
28	31118121	REFUERZO INFER.BALDA 6 CANALES
28	31118131	REFUERZO INFER.BALDA 4 CANALES
29	31149231	SOPORTE DERECHO PENDULO H
31	31149221	SOPORTE IZQUIERDO PENDULO H
32	41197271	CTO. PENDULO 6 CANALES H
33	11019191	GUIA HUSILLO 78

TIENDA VENDING

PALMA Hz

A70004005

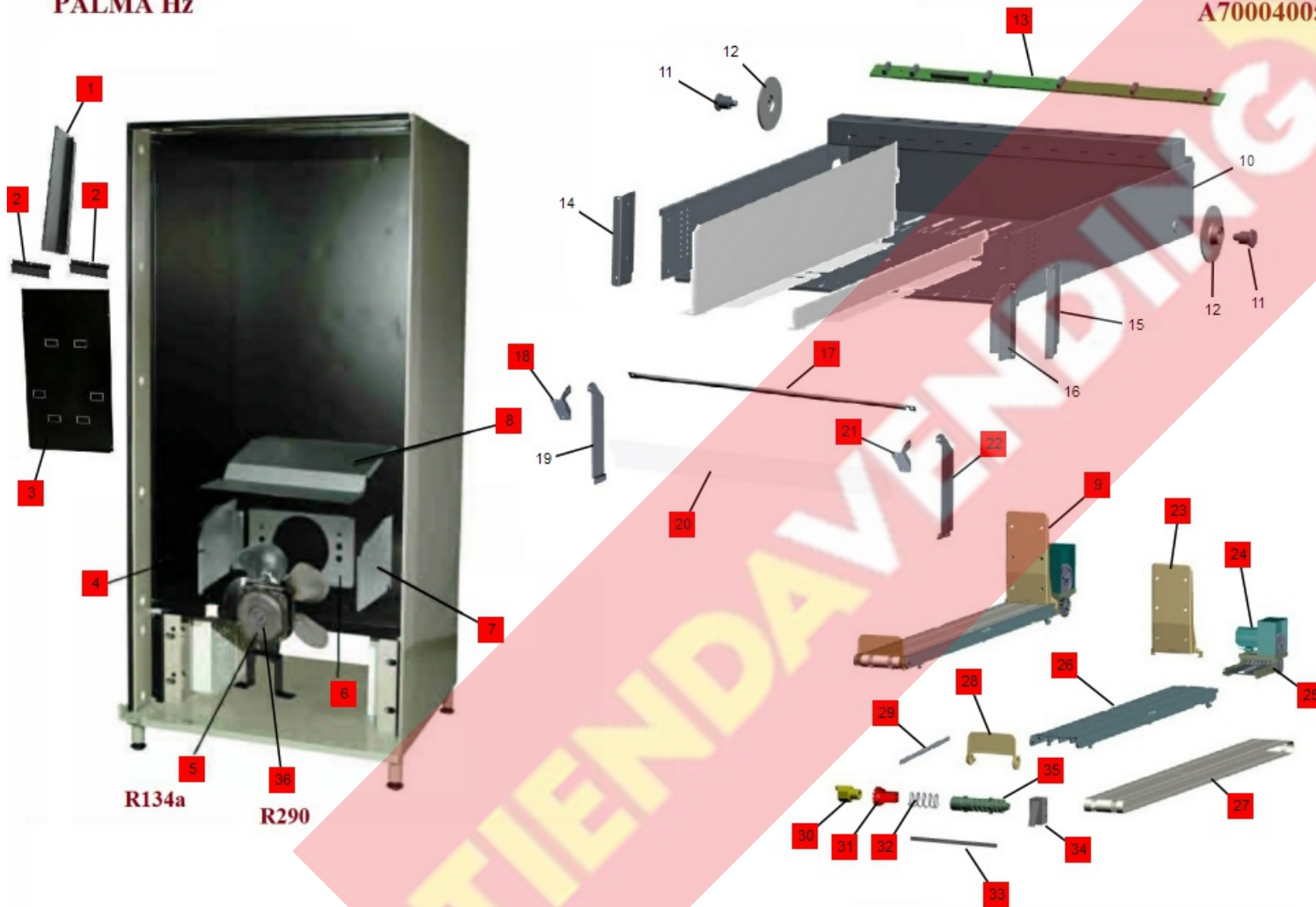

Pos.	Referencia	Denominación
1	3107679101	CONDUCTO AIRE 2 TEMP. NEGRO
2	3107680101	TAPA SUP. DIFUSOR NEGRA
3	3107297101	DIFUSOR AIRE HUSILLOS
4	31114670	LAT.DCHO.COLECTOR ASPIRAC.
5	41080231	CTO.MOTOR VENTILADOR
6	31114650	TABIQ.SEPARADOR AIRE PAL.H BP
7	31114680	LAT.IZDO.COLECTOR ASPIRAC.
8	31114660	TAPA COLECTOR ASPIRAC.PAL.H BP
9	41219211	CTO. CINTA
9	41254831	CTO CINTA CP R290
13	43308341	TARJETA BALDA 6 TROPICALIZADA
13	43308351	TARJETA BALDA 8 TROPICALIZADA
17	31210050	REFUERZO PENDULO
18	42962140	LATERAL DCH. PENDULO
20	39024480	PENDULO
21	42962150	LATERAL IZQ PENDULO
22	31209681	SOPORTE PENDULO IZQUIERDO
23	11043871	EMPUJADOR DE CORREA
24	41221361	CTO. REDUCTORA CINTAS
25	41219221	CTO. MOTOR CINTA
26	11043801	APOYO PRINCIPAL CORREA
27	19068010	CINTA
28	11043841	VAIVEN CIERRE CINTA
29	12017910	MUELLE BLOQUEO TRAMPILLA
30	11043861	EMBRAGUE
31	11043831	RODILLO ARRASTRE
32	12017880	MUELLE TRINQUETE
33	10038870	EJE CONDUCTOR
34	04000980	MICRO OMRON D2F-L
35	11043821	RUEDA CONDUCTORA
36	41251511	CTO. VENTILADOR PALMA R290

PALMA Hz

A7000406



GAS R 134a

GAS R 290

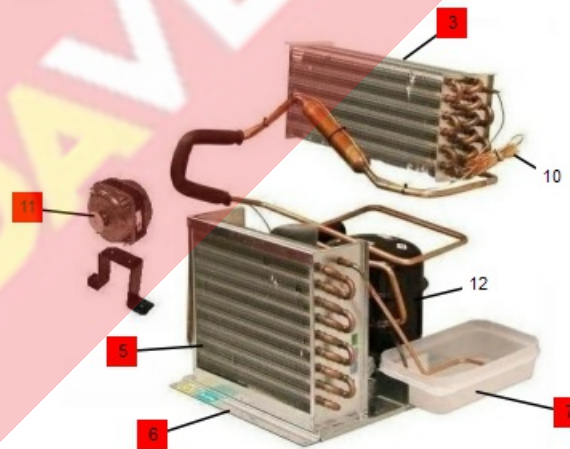
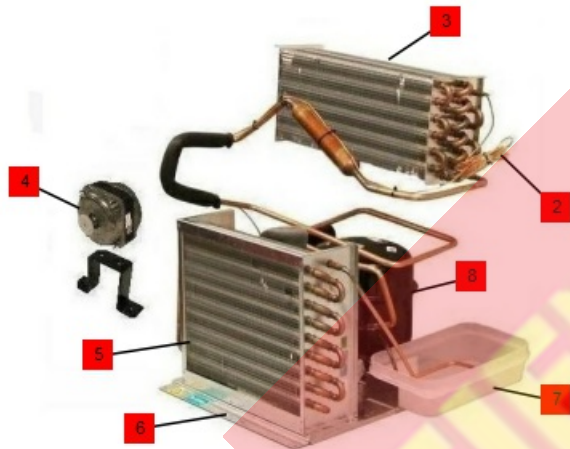

Pos.	Referencia	Denominación
1	41080241	CTO.GRUPO FRIO PALMA
2	39012220	CAPILAR PALMA
3	19015161	EVAPORADOR PALMA
4	41049361	CTO.MOTOR VENTILADOR N-7
5	09703590	CONDENSADOR CAT 9X3
6	42915250	SUBCTO.BASE GRUPO DE FRIO
7	09707310	BANDEJA ARAVEN 3027 2,8 L.
8	41080241	CTO.GRUPO FRIO PALMA
9	41248161	CTO GRUPO FRIO PALMA R290 220V 50HZ
11	41251501	CTO. VENTILADOR GRUPO PALMA R290

TIENDA VENDING

PALMA HZ
BALDA CON NUEVA ESTETICA
BALDA REGULABLE

A70004007

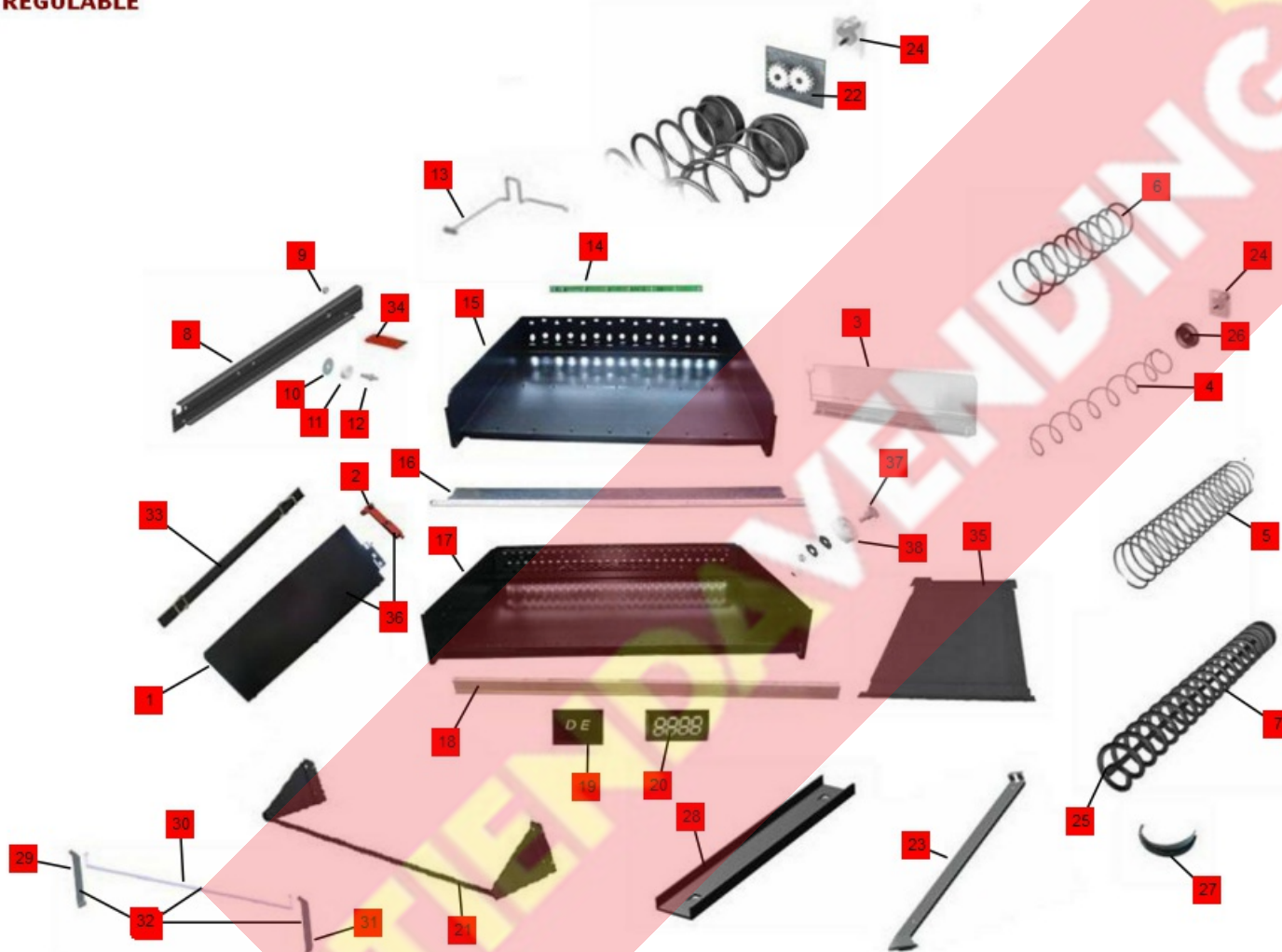

Pos.	Referencia	Denominación
1	31170731	TABIQUE SANDWICH
2	11022971	GATILLO TABIQUE
3	1101916103	TABIQUE SEPARADOR GR. TRANSP.
3	11037242	TABIQUE BOTES-BOTELLAS H TRANSP.
4	1901489101	HUSILLO 78 35 NEGRO
4	1901490101	HUSILLO 78 45 NEGRO
4	1901491101	HUSILLO 78 55 NEGRO
4	1901492101	HUSILLO 78 65 NEGRO
4	1901549101	HUSILLO 78x85 GR. NEGRO
5	1901482101	HUSILLO 65 20 NEGRO
5	1901483101	HUSILLO 65 25 NEGRO
5	1901484101	HUSILLO 65 30 NEGRO
5	1901485101	HUSILLO 65 35 NEGRO
5	1901486101	HUSILLO 65 40 NEGRO
5	1901487101	HUSILLO 65 50 NEGRO
5	1901488101	HUSILLO 65 60 NEGRO
5	1901548101	HUSILLO 65 85 NEGRO
5	19024221	HUSILLO 65-77 6 LATAS
6	1901506101	HUSILLO 65C 40 NEGRO
6	1901507101	HUSILLO 65C 50 NEGRO
6	1901508101	HUSILLO 65C 60 NEGRO
6	1901644101	HUSILLO 65X25 C NEGRO
6	1901645101	HUSILLO 65C 30 NEGRO
6	1901646101	HUSILLO 65X35 C NEGRO
6	1901647101	HUSILLO 65C 85 NEGRO
7	1901514101	HUSILLO 65D 20 NEGRO
7	1901515101	HUSILLO 65x30 D-GR. NEGRO
8	41126001	CTO.GUIA BALDA SUP.DCHO PAL,Z
8	41126011	CTO.GUIA BALDA SUP.IZDO PAL,Z
8	41126021	CTO.GUIA BALDA INF.DCHO HZ
8	41126031	CTO.GUIA BALDA INF.IZDO HZ
9	00002131	TUER.HEX.AUTOBL. DIN985 M5 BL
10	10011881	SUPLEMENTO RUEDA RESBALON
11	11000151	RUEDA RESBALON
12	10011231	EJE RUEDAS BALDA
13	43210580	MAZO BALDA HUSILLOS

Pos.	Referencia	Denominación
14	43308341	TARJETA BALDA 6 TROPICALIZADA
14	43308351	TARJETA BALDA 8 TROPICALIZADA
15	11040591	BALDA 8 CANALES PERFIL
15	11040601	BALDA 6 CANALES PERFIL
16	31173640	REFUERZO INFERIOR BALDA 8C PERFIL
16	31173650	REFUERZO INFERIOR BALDA 6C PERFIL
17	42212971	SUB. BALDA REGULABLE 8 CANALES
17	42212981	SUB. BALDA REGULABLE 6 CANALES
18	19062050	FRONTAL BALDA 8 CANALES PLASTICO
18	19062060	FRONTAL BALDA 6 CANALES PLASTICO
18	19062100	FRONTAL BALDA 8 CANALES CHAPA
19	19062141	HOJA DE RÓTULO SELECCION PROD. PALMA II
20	19062151	ROTULO DE PRECIO PALMA - MISTRAL
21	4292061100	SUBC.VARILLA BOTELLAS 8 CANALES
21	4292062100	SUBC.VARILLA BOTELLAS 6 CANLES
22	41132621	CTO.TRANSM.HUSILLO CONTRAR.BP
23	11037291	SOPORTE BOTES-BOTELLAS H
24	41081031	CTO. REDUCTORA HUSILLOS
25	19016380	DIVISOR HUSILLO
26	11019191	GUIA HUSILLO 78
26	11019201	GUIA HUSILLO 65 (SPIRAL END CUP)
26	11035201	GUIA HUSILLO 65 CORTO
27	1101964101	EMPUJADOR PRODUCTO NEGRO
27	11023051	EMPUJADOR PRODUCTO CONTRARIO
27	11023061	EMPUJADOR PRODUCTO 78
28	3107254101	GUIA INFERIOR HUSILLO LARGO
29	31149231	SOPORTE DERECHO PENDULO H
30	11038871	PENDULO 6 CANALES
31	31149221	SOPORTE IZQUIERDO PENDULO H
32	41197271	CTO. PENDULO 6 CANALES H
33	41100421	CTO.REGULADOR LATERAL PRODUCTO
34	39006241	TOPE LIMITADOR PROFUNDIDAD
35	31118261	SEPARADOR 2 TEMP. BALDA 8C
35	31118271	SEPARADOR 2 TEMP. BALDA 6C
36	41204791	CTO. TABIQUE SANDWICH
37	10011231	EJE RUEDAS BALDA

Pos.
38

Referencia
11000151

Denominación
RUEDA RESBALON



PALMA Hz

A70004008

Máq. EPIs y gas R134a

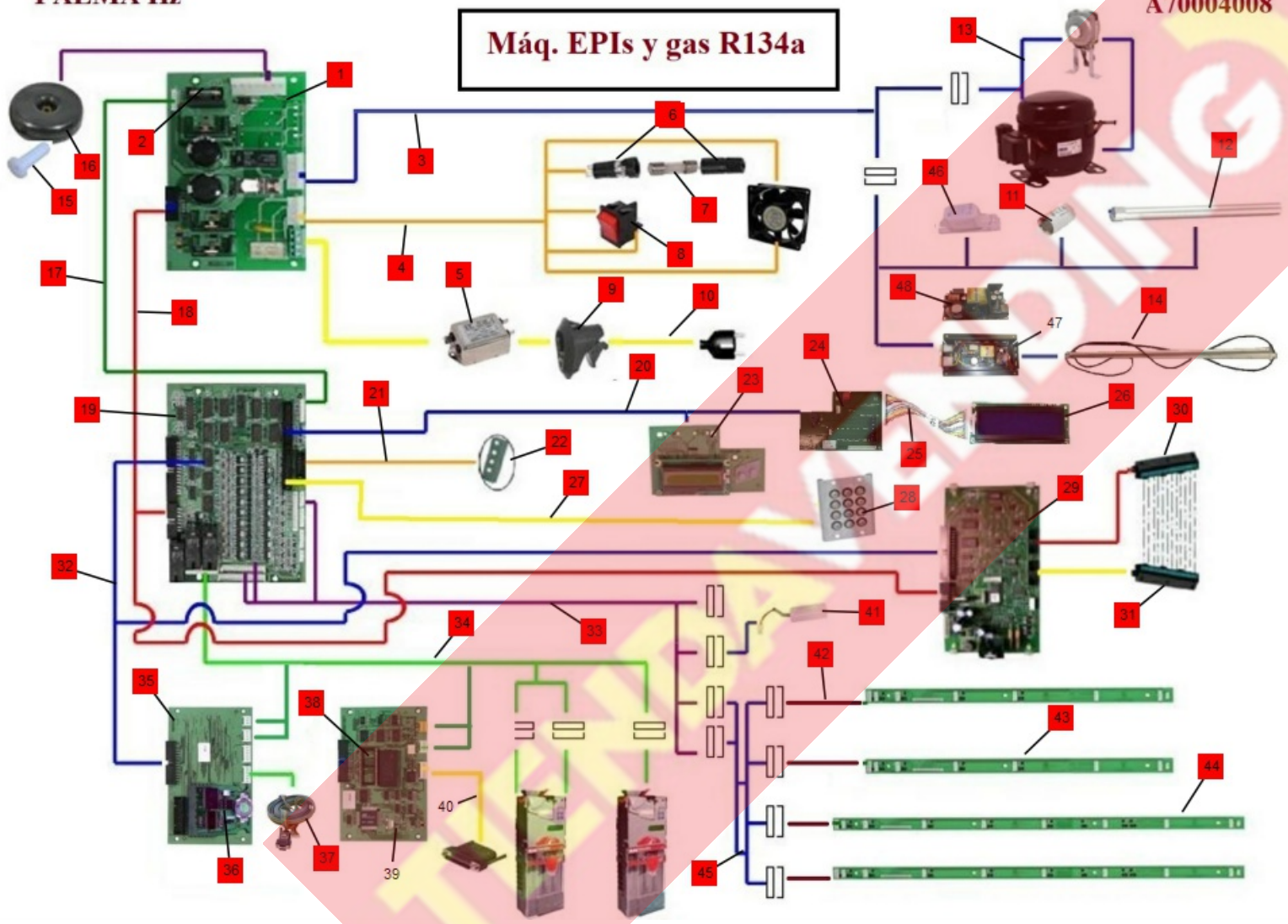

Pos.	Referencia	Denominación
1	4330758000	TARJETA POTENCIA PALMA
1	4330758001	TARJETA POTENCIA PALMA 240V
2	04800150	FUSIBLE TEMPORIZADO TIPO "T" 6,3A
3	43211850	MAZO G.F. E ILUM. SUP. PALMA H
4	43212170	MAZO INTERFACE FILTRO HUSILLOS
5	04802700	RFI FILTRO X-Y 10A 250V
6	04801500	PORTAF.WICKMANM 19823+19837
7	04801580	FUSIBLE TEMPORIZADO TIPO T 10A
8	04000510	INTERRUPTOR IL-902AN/220V.ROJO
9	09702450	SUJETACABLES ITW 0163-010-10
10	43212150	MAZO MANGUERA PALMA FILTRO
10	43212160	MAZO INTERFACE MANGUERA PALMA
10	43212210	MAZO MANGUERA PALMA FILTRO GB.
10	43212220	MAZO MANGUERA PALMA FILTRO aus
11	04200000	CEBADOR 22-65W 220-240V
12	04200900	FLUORESC.PL-L PRO 36W/840 4P
13	43210560	MAZO GRUPO DE FRIO PALMA
14	43124100	CTO. MAZO ILUMINACION LED PALMA 24V
15	11017870	CASQUILLO TRANSFORMADOR
16	4310586000	CTO. TRANSFORMADOR PALMA
17	43210470	MAZO CONTROL RELES GF.
18	43210450	MAZO BUS ALIMENTACION PALMA
19	43307610	TARJETA ENTRADA SALIDA HUSILLO
20	43210490	MAZO DISPLAY PALMA
21	43210550	MAZO INTERF.CAJA PROGRAM.
22	41005771	CJTO.CAJA DE PROGRAMACION
23	43315770	TARJETA DISPLAY PALMA HUSILLOS AZUL
24	43319910	TARJETA NUEVA DISPLAY PALMA HUSILLOS AZ
25	43223030	MAZO CONEXION DISPLAY LCD
26	43315550	DISPLAY LCD CON CONECTOR 16X2 (AV 99X24)
27	43210500	MAZO PULSADORES PALMA
28	41081781	CJTO.SOPORTE+TECLADO PALMA H
29	43317160	TARJETA CONTROL NUEVO IDETECT
30	41144371	CTO.TARJ.DETEC.LADO MONED. HZ
31	41144361	CTO.TARJ.DETEC.LADO BIS.HZ MZ
32	43210460	MAZO BUS CONTROL PALMA

Pos.	Referencia	Denominación
33	43221000	MAZO INTERF. BALDAS PALMA H R
34	43217120	MAZO SISTEMA MONEDA PALMA S/RE
35	41159990	CTO. TARJETA FLASH 5206+RAM
35	43312590	TAR. CONTROL COMUN FLASH 5206E
36	43312600	TARJETA MEMORIA DATOS
37	43210820	MAZO RS232 PC-CONTROL COMUN
38	43524180	MEM. PALMA H BASICA NACIONAL
38	43525420	MEM PALMA HZ ITALIANO+
41	43108610	CTO. MAZO SONDA T PALMA H
42	43210580	MAZO BALDA HUSILLOS
43	43308341	TARJETA BALDA 6 TROPICALIZADA
44	43308351	TARJETA BALDA 8 TROPICALIZADA
45	43217250	MAZO CONEXION BALDA HUSILLOS Z
46	04200700	REACTANCIA 40W 230V 50HZ
48	09720300	FUENTE ALIMENTACIÓN +24V 60W

TIENDA VENDING